



INSTRUCTIONS

GEH-2040A
SUPERSEDES GEH-2040
AND GEI-50293

J. L. STIPE, 10-6

DIRECTIONAL DISTANCE RELAY

Type
CEYB12A

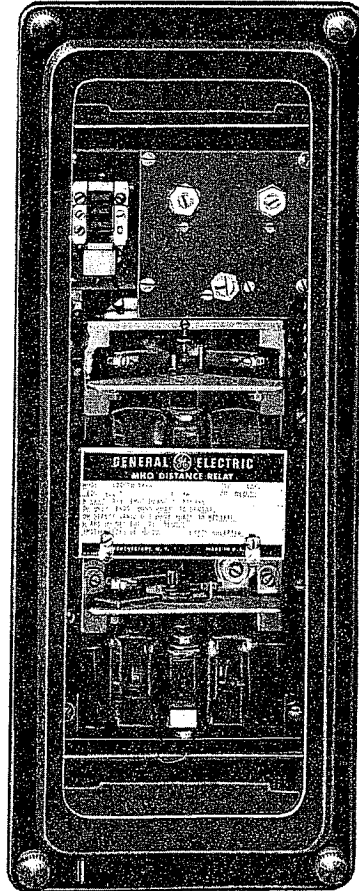

CONTENTS

	PAGE
DESCRIPTION	3
INSTALLATION	9
MAINTENANCE	14
RENEWAL PARTS	19

LOW VOLTAGE SWITCHGEAR DEPARTMENT

GENERAL  ELECTRIC

PHILADELPHIA, PA.

GEH-2040 Directional Distance Relay Type CEYB

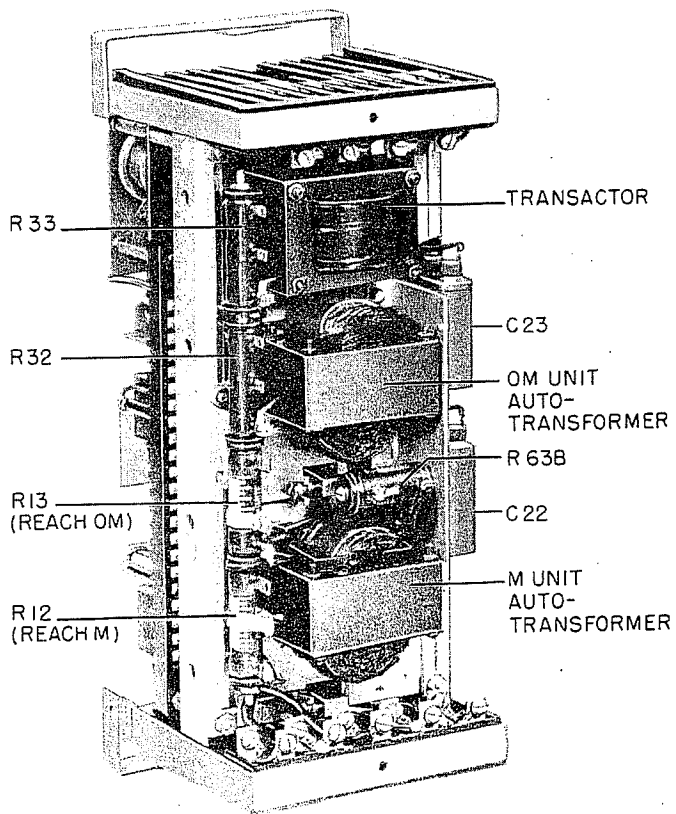
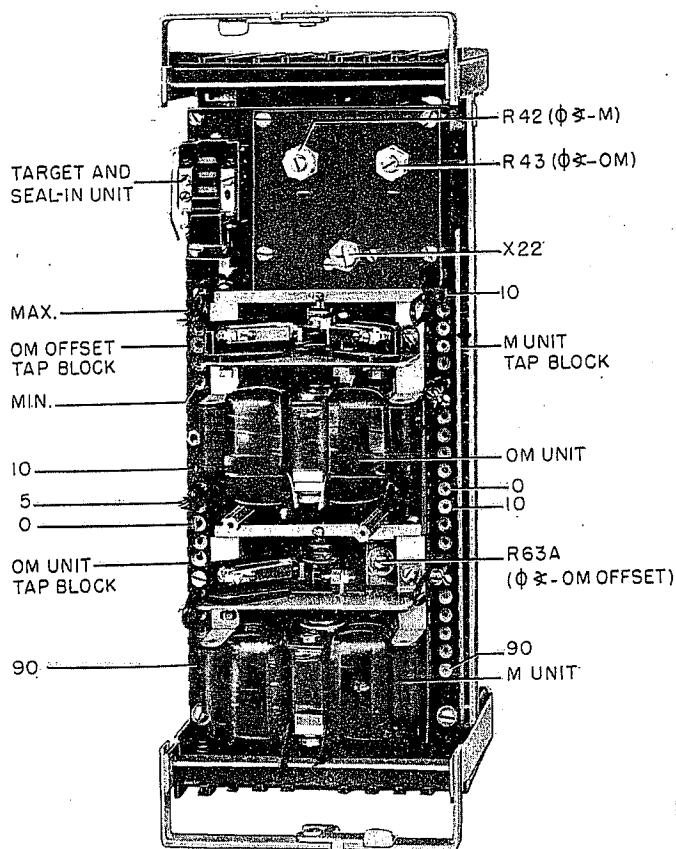

$\phi \text{ ㄨ}$ = Phase Angle

Front View

Back View

Fig. 1 Directional Distance Relay Type CEYB12A Removed From Case

Fig. 1 (8024316) Front View

Fig. 1 (8026146) Back View

Cover (8024450)

DIRECTIONAL DISTANCE RELAY TYPE CEYB12A

DESCRIPTION

INTRODUCTION

The Type CEYB relay is a single phase, high speed, directional distance relay for directional comparison carrier relaying of transmission lines. It is particularly well suited for carrier terminals designed for separate carrier and backup relay circuits and for both relay backup and breaker backup at the local terminal. Three relays are required at each terminal to provide complete protection for three phase, phase to phase, and double phase to ground faults.

APPLICATION

The relay contains two mho units which control the transmission of carrier. These units operate on the induction cylinder principle which provides a high steady torque acting on low inertia parts.

The bottom unit (M) performs the carrier stopping and tripping functions for faults within the protected line section. The mho characteristic, being inherently small, makes the relay relatively insensitive to power swings which may occur on long or heavily loaded lines.

The top unit (OM) is for carrier starting and provides a blocking signal for faults external to the protected section. It is an offset mho unit, i.e., it has a mho characteristic similar to that of the M unit except that it is offset so as to encircle the origin of the impedance diagram instead of passing through it. The mho characteristic is offset by means of the voltage drop across a transactor in the current circuits. Transactor is the name given to a reactor which has a secondary winding with a step up ratio so as to provide high reactance with low burden on the current circuits.

Both mho units are supplied with line-to-line potential and the corresponding phase currents. The mho unit, within itself, measures the vector difference between the two currents. In this way, it provides the same reach for three phase, phase to phase, and double phase to ground faults without the use of any auxiliary current transformers.

The ohmic adjustment range of the M unit are 1-3, 2-6, 3-9 or 5-15 ohms phase to neutral. The reach is adjusted within this range by means of a tapped autotransformer which supplies a percentage of the terminal voltage to the restraint circuits, adjustable in one percent steps.

The ohmic adjustment range of the OM unit with no offset is always 3-30 ohms phase to neutral. Its reach is adjusted by means of a second autotransformer which has five percent steps. The ohmic offset of the OM unit is adjustable within the range of 0-2 ohms by means of the transactor which is tapped at 0, 0.25, 0.50, 1, and 2 ohms or 0-1 ohm which is tapped at 0, 0.12, 0.25, 0.5 and 1.0 ohms.

OPERATING CHARACTERISTICS

M UNIT

The minimum operating characteristic of the M unit is shown in Fig. 2. The relay is adjusted for the 75 degree setting of 3 ohms as shown. The size of the circle can be increased by reducing the restraint tap setting of the tapped transformers in the relay. The following formula gives the ohmic reach at other tap settings, with the relay still set for maximum torque of 75 degrees lag.

$$\text{Ohmic Reach (Phase-to-neutral)} = \frac{300}{\text{M Tap Setting (\%)}}$$

The angle of maximum torque can be adjusted continuously from 75 degrees to 60 degrees. This adjustment is made by decreasing the resistance in R_{32} plus R_{42} (see Fig. 1). This involves a decrease in the ohmic reach as indicated by the circle of 60 degree setting in Fig. 2. There are slight variations from relay to relay in the minimum ohmic reach of the M unit when not set at 75 degrees, as indicated in Table I. The same percent variation from the nominal reach can be expected for the other ohmic ranges.

TABLE I

Angle of Max. Torque	Freq.	Minimum Ohmic Reach M and OM
75 Deg.	60	2.94 to 3.06
70 Deg.	60	2.82 to 2.97
65 Deg.	60	2.64 to 2.87
60 Deg.	60	2.37 to 2.78

At reduced voltage, the ohmic value at which the M unit will operate may be somewhat lower than its calculated value. This "pullback" or reduction in reach, is shown in Fig. 3, where the percentage change in relay reach for a constant tap setting is expressed as a function of the three-phase fault current, $I_{3\phi}$. The M unit will operate for all points to the right of the curves. The static curves of Fig. 3 were determined by tests performed with no

These instructions do not purport to cover all details or variations in equipment nor to provide for every possible contingency to be met in connection with installation, operation or maintenance. Should further information be desired or should particular problems arise which are not covered sufficiently for the purchaser's purposes, the matter should be referred to the General Electric Company.

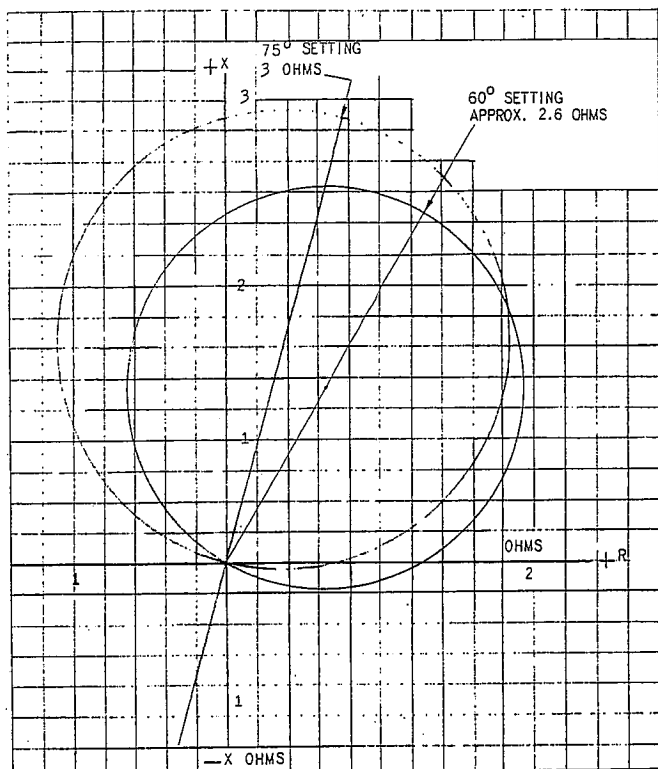

Fig. 2 Minimum Static Operating Characteristics Of The M Unit

voltage supplied to the relay before the fault was applied. The dynamic curves were obtained with full rated voltage of 120 volts supplied to the relay before the fault was applied. These dynamic curves illustrate the effect of the M unit memory action which maintains the polarizing voltage on the unit for a few cycles after the inception of the fault.

This memory action is particularly effective at low voltage levels where it enables the M unit to operate for low fault currents. This can be most forcefully illustrated for a zero voltage fault by referring to Fig. 3. A zero voltage fault must be right at the relay bus and therefore, to protect for this fault, it is imperative that the relay reach zero percent of its setting. Fig. 3 shows the M unit, under static conditions, will not see a fault at zero percent of the relay setting regardless of the tap setting or the magnitude of fault current. However, under dynamic conditions when the memory action is effective, Fig. 3 shows that an M unit with a 100 percent tap setting will pick up if the 3 phase fault current is greater than 1.1 ampere.

The M unit is carefully adjusted to have correct directional action under steady-state low voltage and current conditions. For faults in the tripping direction at the angle of maximum torque, the unit with a 100 per cent tap setting will close its contacts at 1.5 volts and between 2 and 60 amperes for units rated 3 ohms. For other ratings the minimum operating current changes inversely proportional to

the minimum reach. For faults in the non-tripping direction, the contacts will remain open at zero volts and between 0 and 60 amperes. The zero volt test means no voltage applied to the potential circuit and with studs 17 and 18 shorted.

The directional action test has been made using connections as per Fig. 13C. With these connections the relay characteristic is as shown in Fig. 14. i.e., OM is looking backward. If the application requires OM to look forward, a directional test on the M unit must be made and a minor core adjustment will be necessary to obtain the desired directional properties. The directional action of the OM unit is not effected by the change in current coil circuit connections to effect its reversal of the characteristic.

Under transient conditions, the M unit has a tendency to close its contacts momentarily for a fault impedance greater than its impedance setting. This tendency is called transient overreach and is a function of the degree of asymmetry in the fault current wave. For normal CEYB applications, transient overreach is of no significance since the M unit does not perform a precise measuring function. Furthermore, since the M and OM units have similar transient overreach characteristics, for a given fault, the M unit (carrier stop) will not outreach the OM unit (carrier start) at the remote terminal of the line.

The operating times of the M unit for various current levels and percent reach are shown in Figs. 4 and 5. The speed of operation will depend upon the instant in the cycle at which the fault occurs. The operating times shown in Figs. 4 and 5 are maximum, or those produced by the most unfavorable fault inception angle. These operating times will be obtained as long as the M unit reach is not increased beyond the nameplate rating of 9 ohms phase to neutral. If the restraint tap is reduced below 33 percent to obtain more than 9 ohms, the operating times can be expected to increase by as much as one cycle. The current required to produce the same torque for the other ohmic ranges will be inversely proportional to the minimum ohmic reach.

OM UNIT

The OM unit is similar to the M unit with the addition of a transactor. By adding the transactor secondary voltage in series with the terminal voltage and applying the vector sum to the operating unit, the effect is to offset the ohmic characteristic without changing its diameter. Taps are provided on the transactor secondary winding to obtain the desired offset. The offset provides continuous operating torque during low voltage faults.

The ohm unit is also adjusted to have current directional action under steady-state low voltage and current condition. The test is made with zero offset and 100 per cent tap setting. The unit will close its contacts at 6.0 volts between 3 and 60 amperes. With the potential circuit shorted the contacts will remain open from 0 to 60 amperes.

Referring to Fig. 6, the OM unit characteristic at 75 degrees with zero offset is the same as the M unit characteristic except it is rotated 180

Fig. 2 (389A778-2)

Fig. 3 (459A280-0)

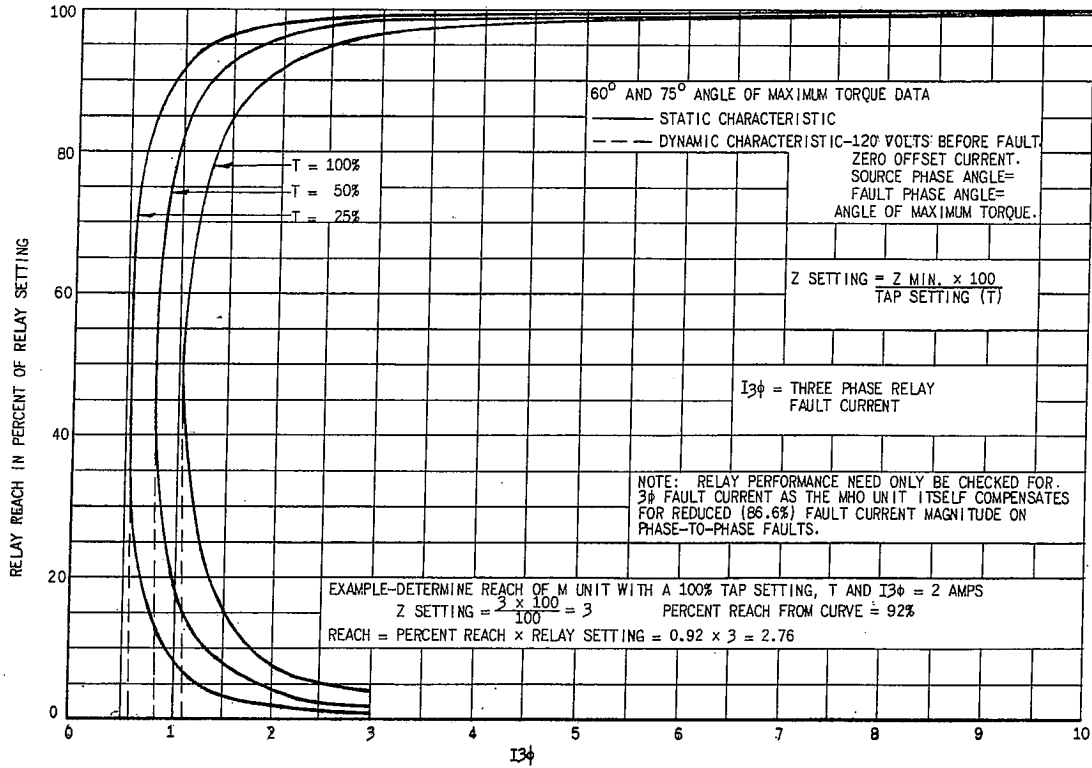

Fig. 3 Static And Dynamic Accuracy Of The M Unit At Its Angle Of Maximum Torque

NOTE: Fig. 3 is for the 3-ohm minimum M unit, for other ohmic ranges multiply the $I_{3\phi}$ axis by the ratio of: 3/min. ohms.

For example the 1-3 ohm M unit, the $I_{3\phi}$ axis would be relabled 0-30 amperes instead of 0-10 amperes.

Fig. 4 (389A774-2)

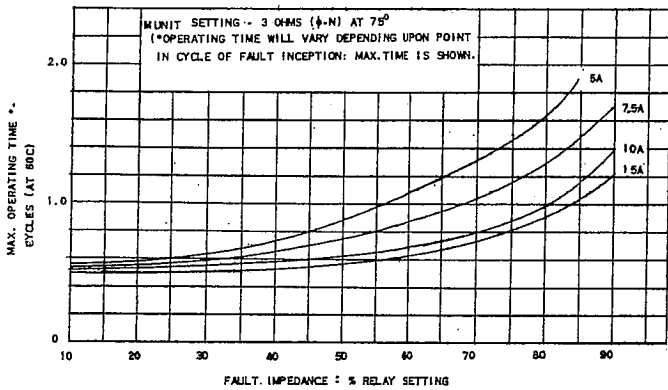

Fig. 4 Operating Characteristics Of The M Unit Set For 3 Ohms At 75 Degrees

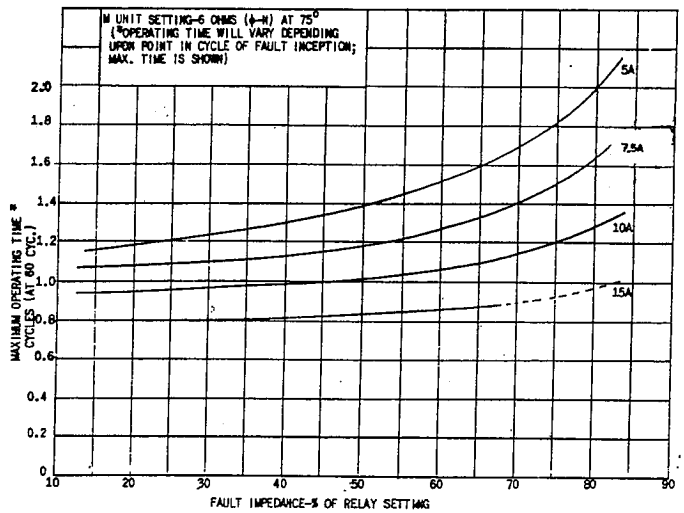

Fig. 5 Operating Characteristics Of The M Unit Set For 6 Ohms At 75 Degrees

electrical degrees. By using the one ohm offset tap, the circle is moved one ohm along its 75 degree characteristic line as shown by the dashed circle.

In the same manner as for the M unit, this circle can be expanded by reducing the voltage supplied to the restraint circuit. To accomplish this, use is made of the OM unit taps, by means of which five per cent steps of the voltage are available. In the case of the OM unit the diameter of the circle will be called the "ohmic setting" instead of the "ohmic reach"; consequently, the ohmic reach may be defined as the ohmic setting reduced by the ohmic offset. Thus for circles with the 75 degree line as a diameter:

$$\text{Ohmic Setting (Phase to neutral)} = \frac{300}{\text{OM Tap Setting (\%)}}$$

When zero offset is used, these circles all pass through the origin as in the M unit. When one ohm offset is used, these circles continue to pass through a common point one ohm away from the origin as shown in Fig. 6 by the dashed circle.

As for the OM unit, the direction of the zero offset characteristic can be adjusted from the 75 degrees setting to any angle down to the 60 degrees setting shown in Fig. 6. This is exactly the same as the M unit, and will have the same variation, in minimum ohmic setting as is indicated in Table I. This adjustment is made by decreasing the resistance in R_{33} plus R_{43} . If no change is made in the setting of R_{63} , and if offset is used, the new circle, initially, at 60 degrees for example, will be shifted along a 75 degree line. In order to have the offset along a 60 degree line, the resistance of R_{63} must be reduced. (See Fig. 1) for resistor location.

The transient overreach characteristics of the OM unit are substantially the same as those of the M unit and are of no significance for the same reason as that give for the M unit.

Operating time characteristics for the OM unit are shown in Figs. 7, 8 and 9. Fig. 7 shows the average operating times for the unit with zero offset and minimum reach (maximum restraint). Fig. 8 shows the average times for opening the normally closed contacts, also with the minimum setting, but with one ohm offset and correspondingly less reach. Comparison of these two curves shows that, in the direction of the units setting, the operating times, plotted as a function of the units reach, are very nearly the same with or without offset. This is true regardless of the offset tap used. The use of offset causes the forward reach to be reduced, so that, in order to obtain the same forward reach, the ohmic setting must be increased by reducing the restraint tap. Any reduction in restraint causes a slight reduction in operating time so that, for faults in the direction of the units setting, the curves of Figs. 7 and 8 are suitable for general use.

It will be noted from Figs. 7 and 8 that the OM unit has considerably longer operating times for faults in the offset direction than for faults in the

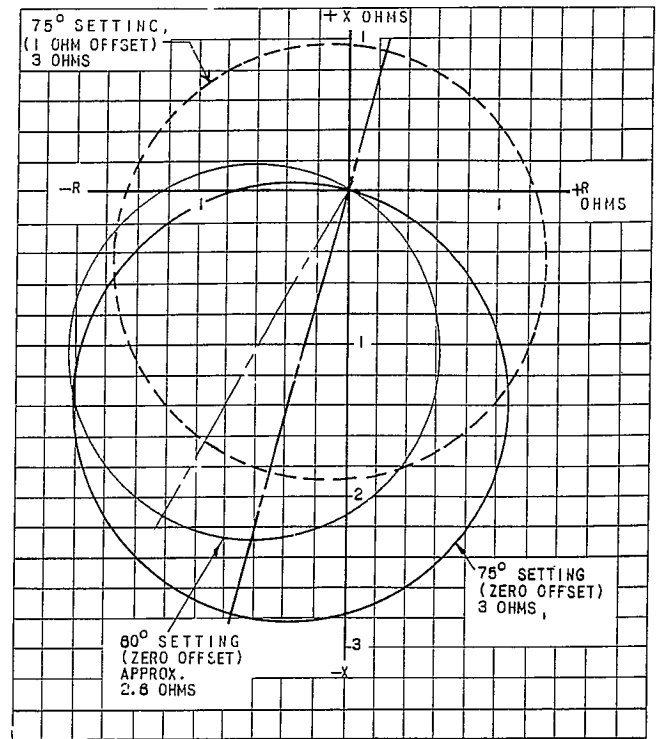

Fig. 6 Minimum Static Operating Characteristics Of The OM Unit

direction of the units setting. Furthermore, the operating times for faults in the offset direction vary for different offset tap settings. However, this is of no practical significance since the only purpose of using offset is to obtain positive, high speed operation for turning on carrier for close in external faults and bus faults. To insure this, it is recommended that some offset always be used, up to one half the ohmic setting of the unit.

Fig. 9 shows a typical spread between the average operating times, and maximum operating times of the normally closed contacts.

Fig. 10 illustrates the characteristics of both units as they would appear on a typical carrier application for transmission line protection.

RATINGS

The Type CEYB12A is rated 120 volts 5 amperes 60 cycles.

The M unit is available with ohmic ranges of 1-3, 2-6, 3-9 and 5-15 ohms phase-to-neutral, at the units maximum torque angle of 75 degrees lag. The ohmic setting is adjustable between the rated ohmic range in one per cent steps via a tapped auto transformer.

The OM unit has an ohmic range, phase-to-neutral of 3-30 ohms and 75 degrees angle of maximum torque. The ohmic setting of the OM unit between these limits can be made in 5 percent steps.

Fig. 6 (K-6556576-1)

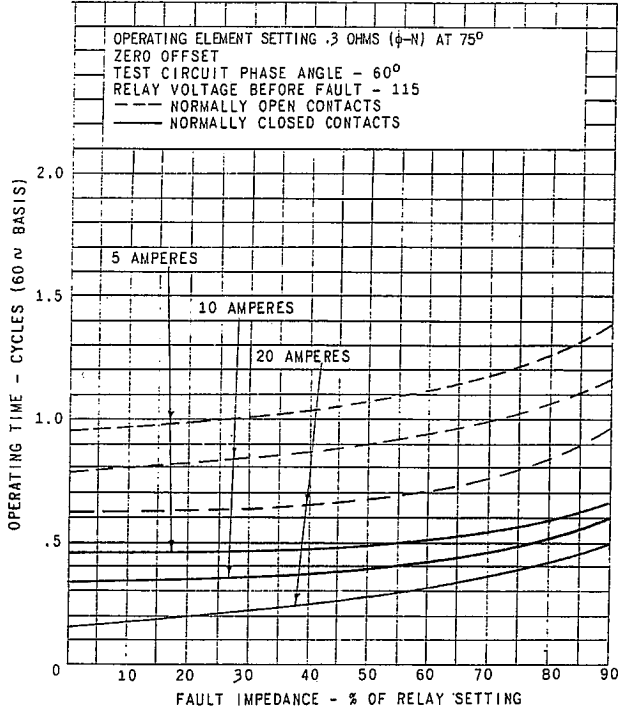

Fig. 7 Average Operating Characteristics Of The OM Unit Set For 3 Ohms At 75 Degrees And Zero Offset

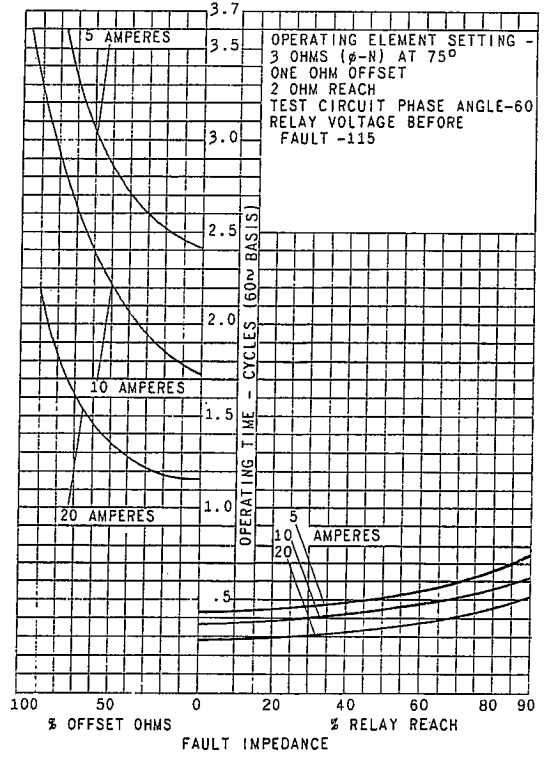

Fig. 8 Average Operating Characteristics Of Normally Closed Contacts Of The OM Unit

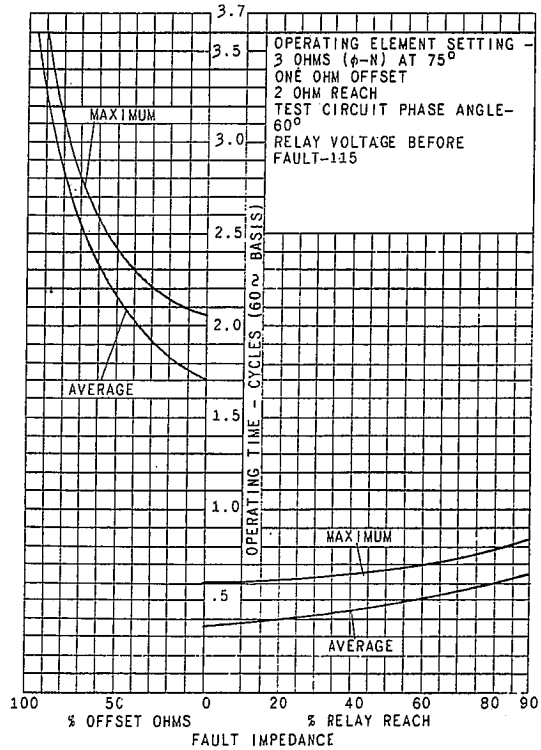

Fig. 9 Operating Characteristics Of The Normally Closed Contacts Of The OM Unit At 10 Amperes Fault Current

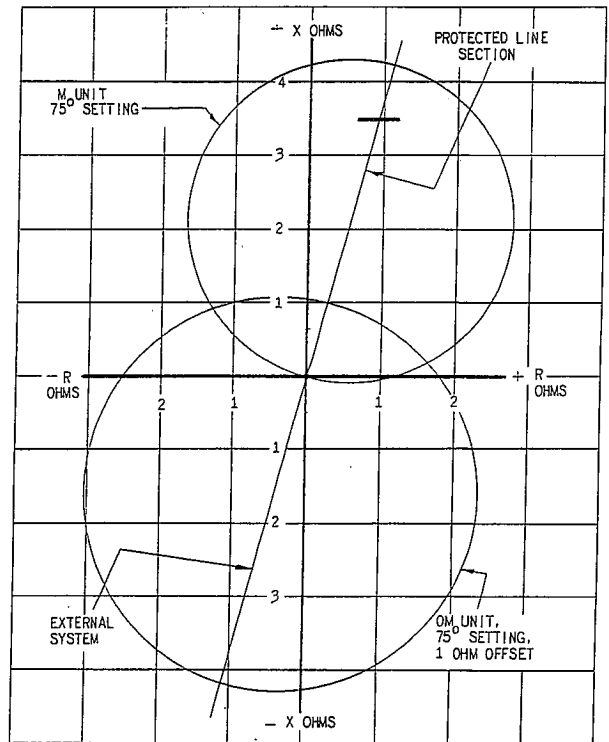

Fig. 10 Typical Static Operating Characteristics Of The Type CEYB12A Relay

The circuit closing contacts of the relays will close and carry momentarily 30 amps d-c. The breaker trip circuit, however, should always be opened by an auxiliary switch or other suitable means; it cannot be opened by the tripping relay contacts or by the contacts of the units. If the tripping current should exceed 30 amperes, it is recommended that an auxiliary tripping relay be used.

The combination target and seal-in unit has a dual rating of 0.6/2.0 amperes. The tap setting is determined by the current drawn by the trip coil. The 0.6 ampere tap is normally used with trip coils which operate on currents ranging from 0.6 amperes to 2.0 amperes at the minimum control voltage while the 2.0 amperes tap should be used when trip currents are greater than 2.0 amperes. It is not good practice to use the 0.6 ampere tap when the trip current is greater than 15 amperes since the 0.6 ohm resistance of the 0.6 ampere tap will cause an unnecessarily high voltage drop which will reduce the voltage of the circuit breaker trip coil.

TABLE II
TARGET & SEAL-IN UNIT

Function	Amperes AC or DC	
	2-Amp Tap (0.3 ohms)	0.6 Amp Tap (0.6 ohms)
Carry for Tripping Duty	30	15
Carry Continuously	4	0.8
Min. Target Operating	2	0.6

The normally closed contacts of the OM unit will close, carry continuously and open 0.3 amperes in non-inductive circuits up to 250 volts.

BURDENS

Because of the presence of the transactor in the relay the ohmic burdens imposed upon the current and potential transformers by the OM unit are not constant, but vary somewhat with the ohmic reach, amount of offset, and current. This variation is of little importance to the current transformer, so that a formula for calculating only the potential burden will be given.

CURRENT CIRCUITS

The maximum current burden (3 ohm min. reach) imposed on each current transformer by a practical setting on a three-phase terminal of three CEYB relays, at 5 amperes, and rated frequency:

Freq.	Watts	Vars	Volt-Amperes
60	8.2	8.8	12.0

This corresponds to:

Freq.	R	X	Z
60	0.32	0.35	0.48

The above burdens were measured under phase-to-phase fault conditions which yield higher burden

readings than balanced 3 phase conditions. Also any other change caused by different conditions in the OM unit will cause the burden to be slightly less than indicated.

POTENTIAL COILS

The maximum potential burden imposed on each P.T. by a practical setting on a three-phase terminal of three CEYB relays at 120 volts, 5 amperes and rated frequency is as follows:

Freq.	Watts	Vars	Volt-Amperes
60	30.0	18.2	35.3

The potential burden of both units is altered by changing the restraint setting in order to choose the proper reach, as well as by changing the offset adjustment. In order to present equations for calculating the burden, the following symbols will be used:

$$W_M + j V_M = \text{Volt Amperes in M}$$

$$W_{OM} + j V_{OM} = \text{Volt Amperes in OM}$$

E = Relay Terminal Voltage

Z_O = Ohmic Offset (secondary)

Z_L = Ohms through the fault or load (secondary)

Z_S = Self impedance of OM potential circuits

M = M restraint tap setting in percent

OM = OM restraint tap setting in percent

The burden for any set of conditions can be computed by using the equations given below.

In equation (4), the difference in the angles of Z_O and Z_L may be neglected, so that the volt-ampere burden of the OM unit is the ideal value of (E²/Z_S)(1 ± Z_O/Z_L), where Z_S is a complex value computed from the potential circuit impedance and the mutual coupling with the current circuits, and where the scalar value of Z_O/Z_L may be used.

The choice of the positive or negative sign in the correction factor (1 ± Z_O/Z_L) is determined by the direction of fault relative to the direction of offset. If they are opposite, the sign is plus.

**POTENTIAL CIRCUIT BURDEN EQUATIONS
(60 CYCLES)**

$$\text{Total Burden} = W_M + W_{OM} + j(V_M + V_{OM}) \quad (1)$$

$$W_M = 8.6 + \left(\frac{M}{100}\right)^2 \quad (5.4) \quad (2)$$

$$V_M = 0.8 + \left(\frac{M}{100}\right)^2 \quad (7.0) \quad (3)$$

$$W_{OM} + j V_{OM} = \frac{E^2}{Z_S} \left(1 \pm \frac{Z_O}{Z_L}\right) \quad (4)$$

$$Z_S = \frac{1900(952 + j 1050)}{(OM)^2(0.19 + j 0) + 952 + j 1050} + Z_O^2(4.5 + j 14.5) \quad (5)$$

GENERAL CONSTRUCTION

The mho units of the CEYB12A relay are of the four pole induction cylinder construction. The schematic connections for this unit are shown in Fig. 11. The two side poles, energized with phase-to-phase voltage, produce the polarizing flux which interacts with the flux produced in the back poles energized with a percentage of the same voltage to produce the restraint torque in the relay. The flux produced in the front pole, energized with the two line currents associated with the phase-to-phase voltage used, interacts with the polarizing flux to produce the operating torque. The torque equation at pickup is therefore:

$$T = O = EI \cos(\theta - \phi) - KE^2$$

where E is the phase-to-phase voltage

I is the delta current ($I_1 - I_2$)

ϕ is the angle of maximum torque of the relay.

θ is the power factor angle

K is the design constant

INSTALLATION

RECEIVING

These relays, when not included as a part of a control panel, will be shipped in cartons designed to protect them against damage. Immediately upon receipt of a relay, examine it for any damage sustained in transit. If injury or damage resulting from rough handling is evident, file a damage claim at once with the transportation company and promptly notify the nearest General Electric Apparatus Sales Office.

Reasonable care should be exercised in unpacking the relay in order that none of the parts are injured or the adjustments disturbed.

If the relays are not to be installed immediately, they should be stored in their original cartons in a

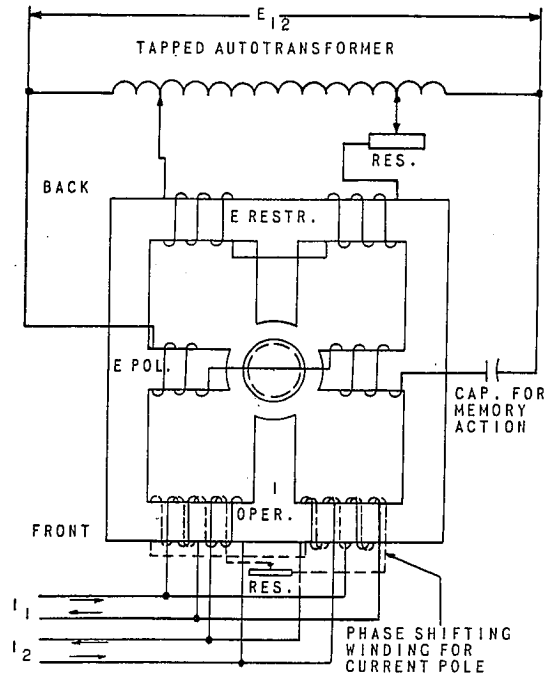

Fig. 11 Schematic Connections Of The MHO Units Associated With Phase 1-2 (Top View)

Dividing through by E^2 and transposing reduces the equation to:

$$Y \cos(\theta - \phi) = K$$

Thus the relay will pick up at a constant component of admittance at a fixed angle depending upon the maximum torque angle of the unit, hence the name mho unit.

A combination target and seal-in element is mounted at the top of the relay and is connected in series with the tripping circuits.

Fig. 1, shows the locations of the component parts of the relay visible when the relay is removed from its case.

INSPECTION

Before placing a relay into service, the following mechanical adjustments should be checked, and faulty conditions corrected according to instructions for the preceding adjustments or under MAINTENANCE.

The armature and contacts of the target and seal-in unit should operate freely by hand.

There should be a screw in only one of the taps on the right-hand contact of the target and seal-in unit.

Fig. 11 (K-6556581-1)

The target should reset promptly when the reset button at the bottom of the cover is operated, with the cover on the relay.

Check the M and OM units for proper shaft end play, undue friction and correct contact adjustment: The shaft end play should be .005-.010 inch. Check for undue friction in the moving assembly. The moving assembly is not counterbalanced. Hence, if the relay is tilted slightly side ways the contact will move. If the assembly does not respond by moving away from the backstop, in the case of the M unit, or the right hand contact for the OM unit as the relay is tilted there, is friction present. A larger degree of tilt will be required on the OM unit because of the stronger control spring force. The spring on M unit is adjusted to just touch the backstop when the relay is level. Friction may be due to foreign material in the air gaps or in jewel bearing. An inspection of the jewel bearing can readily be made to check for dirt or a cracked jewel. Clearing up the air gap will require removal of the cup & shaft assembly. Do not oil the jewel. Check the contact adjustment as per Fig. 21.

Check the gram pressure required to cause the clutch to slip. Apply the gauge normal to the moving contact. M should slip between 4-8 grams, OM should slip between 45-60 grams.

CAUTION:

Every circuit in the drawout case has an auxiliary brush; this is the short one in the case (not on the cradle) which the connection plug or test plug should engage first. On every current circuit or other circuit with a shorting bar, make sure these auxiliary brushes are bent high enough to engage the connection plug or test plug before the main brushes in the case do, as otherwise the CT secondary circuit may be opened (where one brush touches the shorting bar) before the circuit is completed from the plug to the other main brush.

SETTINGS

LOCATION AND MOUNTING

The location should be clean and dry, free from dust and excessive vibration, and well lighted to facilitate inspection and testing.

The relay should be mounted on a vertical surface. The outline and panel drilling diagram is shown in Fig. 21.

The rotating structure of the mho units is not balanced, so that any slight torque caused by a tilt of the shaft when the relay is installed ready for operation should be compensated for using the

control spring adjusting arm at the top rear of the unit. See CONTROL SPRING ADJUSTMENT under MAINTENANCE for proper setting of the control spring.

ADJUSTMENTS AND TESTS

The relay is properly calibrated at the factory and it is not advisable to disturb the adjustment. If it is necessary to check the factory calibration, refer to the MAINTENANCE section of this book where detailed instructions are given under the SERVICING subsection.

To make the proper tap settings of the units, the following procedure may be used. To set the units by test, refer to the SERVICING subsection.

M UNIT

At the time the relay is put in service, it is necessary to make appropriate restraint tap settings to adapt the relay most advantageously to the particular application. The line impedance as viewed from the secondary can be calculated from the formula:

$$Z_{sec.} = Z_{pri.} \times \frac{CT \text{ ratio}}{PT \text{ ratio}}$$

The restraint tap setting can then be determined from the relationship:

$$\% \text{ tap} = \frac{\text{Min. Ohmic Reach}}{\text{Desired Ohmic Reach}} \times 100$$

The M tap setting is made on the right-hand tap block. The lower jumper labeled M is connected to one of the ten per cent step taps on the lower half of the block, and the upper M jumper is connected to one of the eleven one percent step taps (either jumper may be connected to the zero tap) so that the sum of the two taps used is the desired setting.

In making these settings and calculations the following points should be remembered:

1. All values of ohmic reach are phase-to-neutral as noted on the nameplate.
2. The ohmic reach is inversely proportional to the tap setting on the right-hand tap block. For example, if 100 per cent will give a 3 ohm reach with the 75-degree angular setting, then 75 per cent would give a 4-ohm reach.
3. The reach at some angle different from maximum torque is less by the cosine of the angle between the line and the relay maximum torque. For example, the reach along a 70-degree line with a 75-degree relay setting would be the cosine of 5-degrees times the reach at maximum torque as determined from the preceding paragraphs.
4. The ohmic reach must not be great enough to cause the M unit (carrier stop) to outreach the OM unit (carrier start) at the remote terminal.

OM UNIT

The operating element of the OM unit has the same basic circuit elements as the M unit so that, with slight modification, the procedure for adjustment will be the same. Without offset, the restraint adjustment is the same as for the M unit. The OM tap settings are made on the left hand tap block.

When offset is used, the setting of the OM unit, defined as the diameter of its ohmic characteristic, is equal to the sum of the ohmic reach plus the offset. There is an appreciable increase in the ohmic setting for a given OM tap setting when offset is used. This varies with the OM tap setting and the offset, but can be approximated as a 7 per cent increase in the diameter of the ohmic characteristic for practical settings. Using this approximation, the setting of the OM tap can be calculated from (6) and (7) when the angular settings of the operating element and the transactor are the same.

$$\text{OM Tap Setting (\%)} = 107 Z_M / (Z_O + Z_R) \quad (6)$$

$$Z_R = \frac{Z_L^2 + Z_O Z_L \cos(\phi - \theta)}{Z_O + Z_L \cos(\phi - \theta)} \quad (7)$$

Z_R = Ohmic reach at angular setting of unit

Z_M = Min. ohmic reach at angular setting of unit

Z_L = Desired ohmic reach at angle θ , if θ and ϕ are different

Z_O = Ohmic offset

θ = Line angle

ϕ = Angular setting of unit.

Fig. 12 shows the static characteristic of the OM unit showing angular relationships of impedance quantities in equation 7.

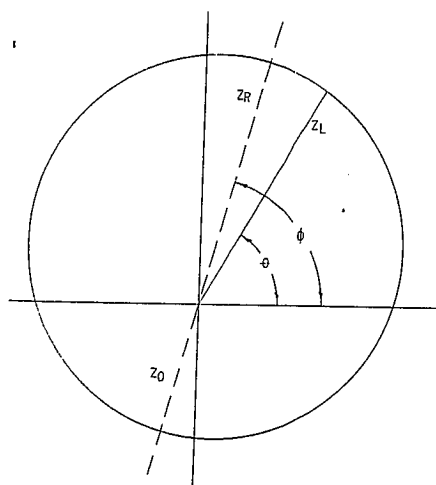

Fig. 12 (459A263-0)

Fig. 13 (459A264-0)

Fig. 12 Static Characteristics Of The OM Unit Showing Angular Relationship Of Impedance Given In Equation 7

TARGET AND SEAL-IN UNIT

The choice of tap on the target and seal-in unit is described above under RATINGS. To change this tap, the spare screw above the left contacts should be inserted into the vacant tap on the right-hand contact, and the other screw removed and placed in the spare position. Do not leave screws in both taps on the right-side of the unit.

CHECK TESTS

POLARITY

To check the polarity of the relay, the connections of Fig. 13A may be used.

Set the taps on 100 per cent. Set offset on zero.

With the top connection plug only inserted, both units should have strong opening torque.

Remove one of the restraint tap leads from each unit. The contacts are now being held open by control spring restraint only. Inserting the bottom plug should cause the M unit to close and increase in opening torque of the OM unit should result.

OVERALL TESTS

Overall tests on current transformer polarities, relay connections, and wiring can be made on the complete installation. Referring to Fig. 15, a check of the indicated phase angle meter readings will indicate that the relay is receiving the proper voltages and currents from the connections to the current and potential transformers for the conventional connections of Fig. 14.

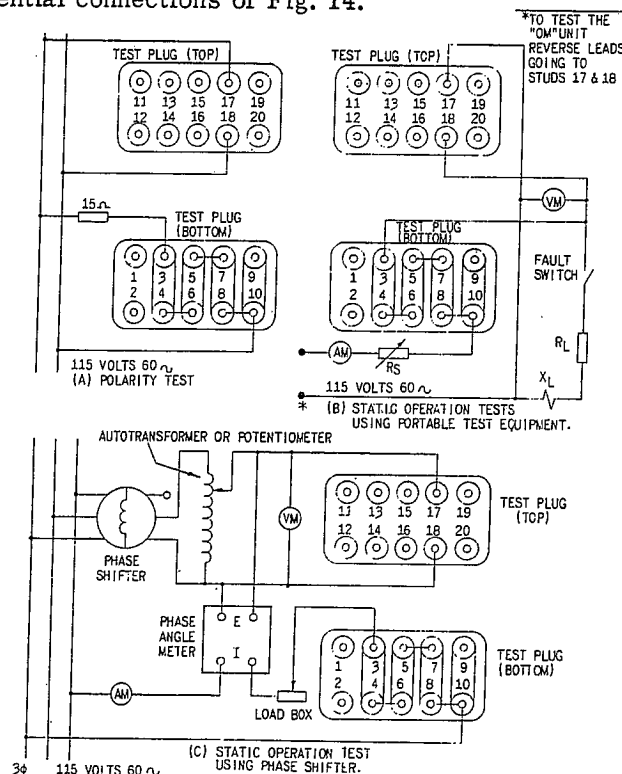
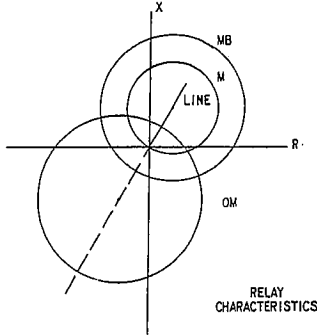

Fig. 13 Test Connections For CEYB12A Relay Using Test Plug (Model XLA12A)

GEH-2040 Directional Distance Relay Type CEYB

TS		CHANNEL TEST SWITCH - 16SB18B499				BACK VIEW	
CONTACTS	HANDLE END	SEND	NOR	REC.	R. S.		
1	1C 2C	2	1	X			
2	1C 2C	2	1	X			
3	3C 4C	4	3	X	X	X	X
4	3C 4C	4	3	X	X	X	X
SPRING RETURN TO NORMAL							

CCS		CHANNEL CUTOFF SWITCH - 16SB18B211				BACK VIEW	
CONTACTS	HANDLE END	OFF	ON				
1	1C 2C	2	1	X			
2	1C 2C	2	1	X			
3	3C 4C	4	3	X			
4	3C 4C	4	3	X			
5	5C 6C	6	5	X			
6	5C 6C	6	5	X			
7	7C 8C	8	7	X			
8	7C 8C	8	7	X			



TABULATION OF DEVICES			
TYPE OR DESCRIPTION	INTERNAL CONNECTIONS	OUTLINE	
BCA11AS	418A997	K-6209272	
CHANNEL CUTOFF SWITCH	SB-1 16SB18B211	116A130	
CHANNEL TEST SWITCH	SB-1 16SB18B499	116A130	
CEB12B	377A103	K-6209274	
CLPG12B	418A899	K-6209276	
CEYB12A	418A878	K-6209274	
NAA22A	K-6400699	K-6209272	
PJC31C (IF USED)	K-6375726	K-6209272	
WILLIAM.DD-71 (SEMI-FLUSH)		K-8904776	
WILLIAM.DD-901 (SURFACE)		376A914	
TELEPHONE JACK		K-6400578	
WHITE LAMP	ET-6	K-6151144	
CARRIER SET 4CS12A1	125V C-7776154	TYPICAL	
CARRIER SET 4CS12A2	250V C-7776155	CARR. SETS	
CHARLITE THERMOSTAT		418A774	
HGA14AM. BACK CONN. (IF USED)	K-6400533	K-6400533	
HGA14AL. FRONT CONN. (IF USED)	377A139	377A139	

LEGEND			DESCRIPTION
DEVICE NO.	DEVICE TYPE	INCL. ELEM.	
ZIC	CEYB	M	MHO TYPE DISTANCE RELAY
		OM	OFFSET MHO UNIT
		T&S1	TARGET & SEAL-IN
50C	PJC	T&S1	TARGET & SEAL-IN
		T&S1	TARGET & SEAL-IN
67GC	CLPG	G1	CARRIER GROUND RELAY
		G2	CARRIER GROUND BLOCKING UNIT
		G2	CARRIER GROUND TRIPPING UNIT
		GD	CARRIER GROUND DIRECTIONAL UNIT
		GD1X	AUX. TO CONTINUE GROUND BLOCKING
		T&S1	TARGET & SEAL-IN
6B	CEB		OFFSET MHO BLOCKING RELAY
		MB	OUT-OF-STEP BLOCKING UNIT
		TR	TRANSACTOR
		OB	AUXILIARY FOR MB
85	BCA	R	CARRIER CURRENT AUX. RELAY
		RH	RECEIVER RELAY OPERATING COIL
		RH	RECEIVER RELAY HOLDING COIL
		GDX	AUX. TO GD
		MX	AUX. TO M
		T	TARGET
85X	NAA		CARRIER AUXILIARY RELAY
		KX	RECLOSURE INITIATING AUXILIARY
		RA	RECEIVER ALARM UNIT
		TB	RECLOSURE BLOCKING AUXILIARY
CCS			CHANNEL CUTOFF SWITCH
TS			CHANNEL TEST SWITCH
94	HGA		AUX. FOR TRIPPING TWO CIRCUIT BREAKERS

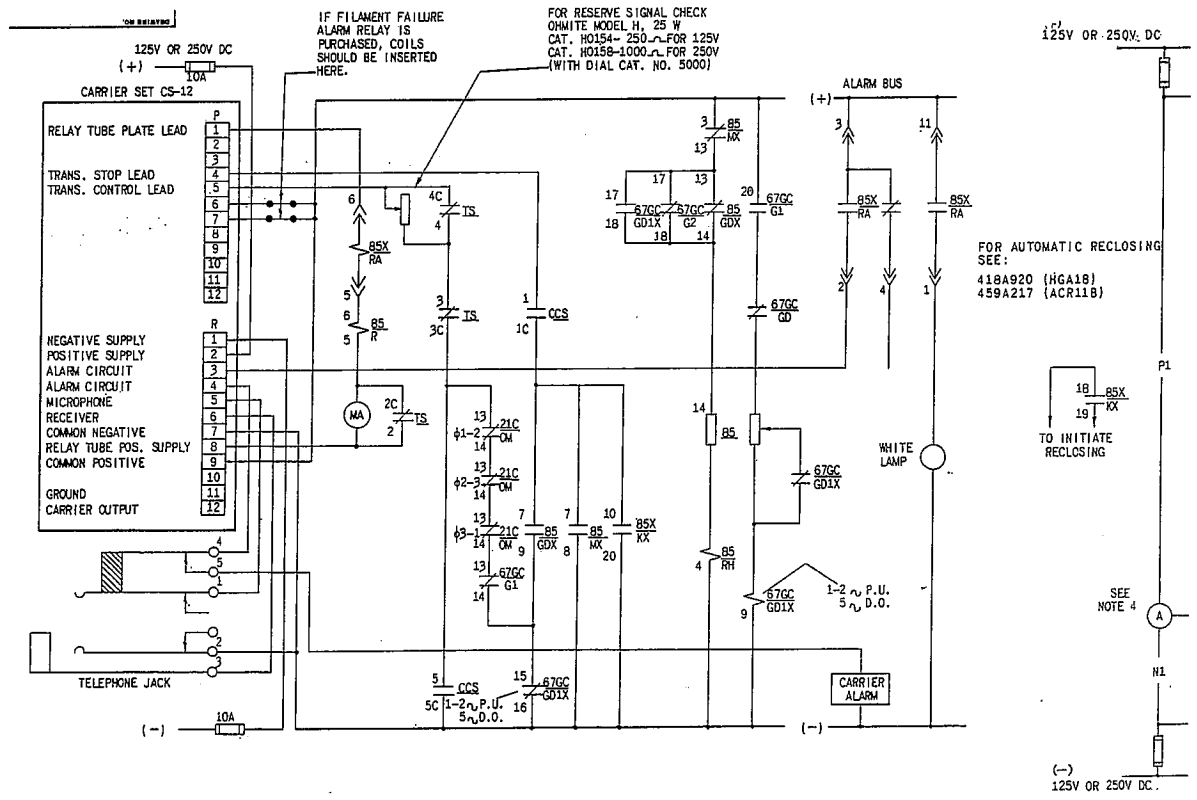

Fig. 14 Elementary Diagram For Carrier Pilot Relaying With Type CEYB12A Relays

Sht. 1 Left Section

Fig. 14 (7021899-0)

Sht. 2 Left Section

Fig. 14 (7021899-4)

Sht.1 Right Section

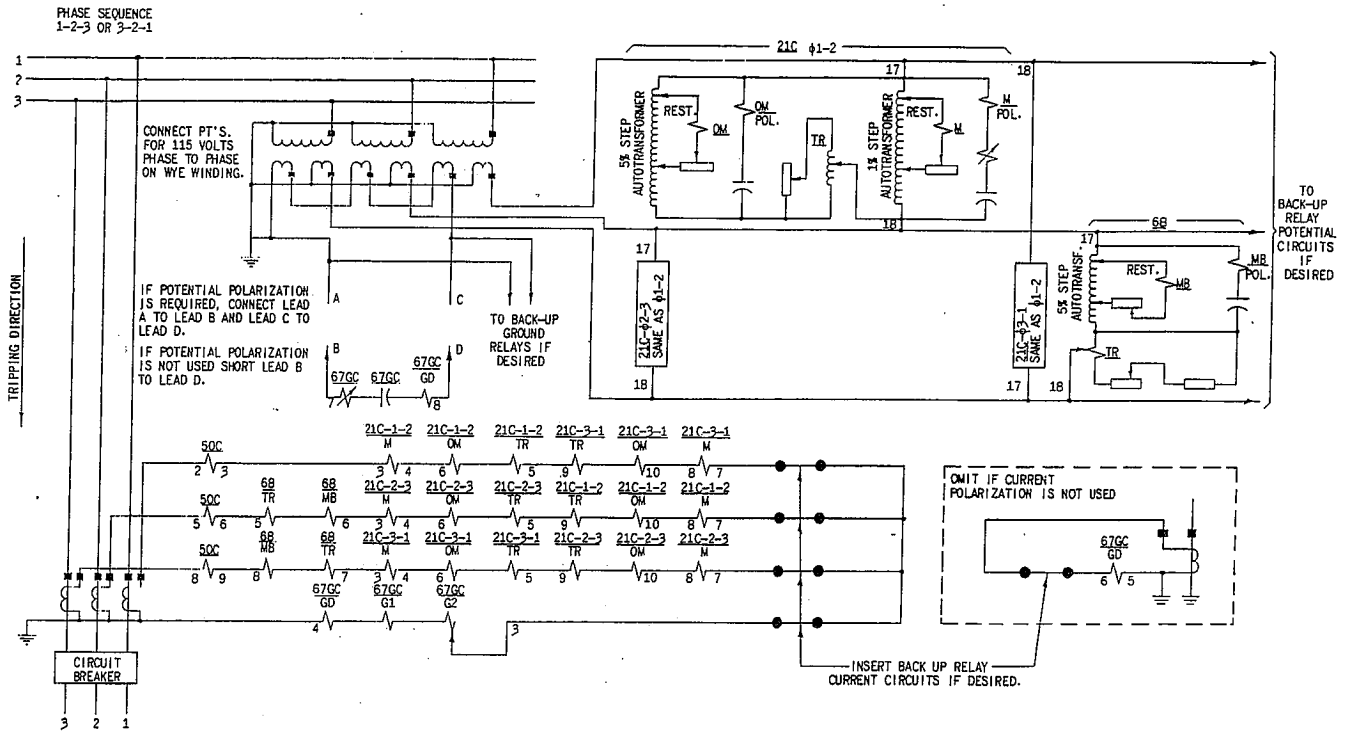

Fig. 14 (7021B99-0)

Sht.2 Left Section

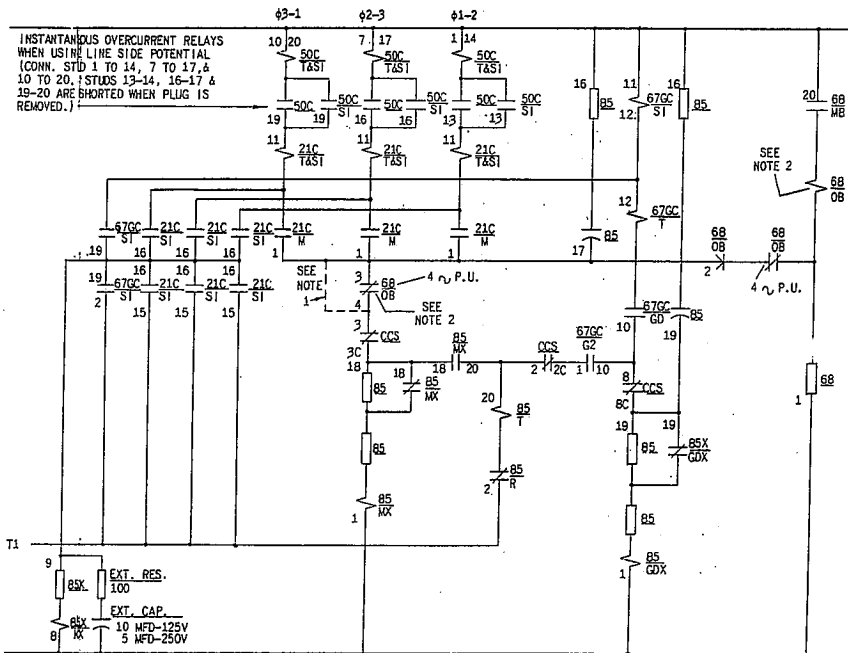

Fig. 14 (7021B99-4)

- NOTE 1:- USE DASH CONNECTIONS IF OUT-OF-STEP BLOCKING IS NOT DESIRED.
- NOTE 2:- IF OUT-OF-STEP BLOCKING RELAY IS USED IN CONJUNCTION WITH THE BACK UP RELAYS ONLY; BUT CONTACTS ARE USED TO BLOCK PRIMARY PROTECTION TOO, IT IS THEN NECESSARY THAT THE RECLOSING DEAD TIME BE LONGER THAN THE DROP OUT TIME OF OB
- NOTE 3:- FOR AUTOMATIC RECLOSING SEE:
418A920 (RGA18E)
458A217 (ACR11B)
- NOTE 4:- IF BREAKER FAILURE SCHEME IS USED, THIS IS CONTINUED ON:
DWG. 7021B999A - SINGLE BREAKER SCHEME
DWG. 7021B999B - DOUBLE BUS DOUBLE BREAKER SCHEME
DWG. 7021B999C - RING BUS SCHEME
DWG. 7021B999D - BREAKER AND A HALF SCHEME.
IF BREAKER FAILURE SCHEME IS NOT USED THIS IS CONTINUED ON INSERT BELOW.

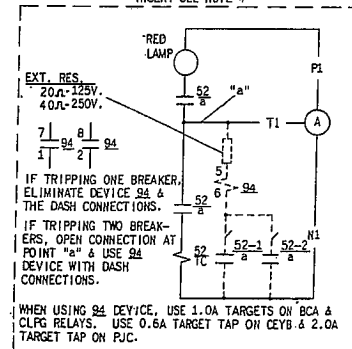

Fig. 14 (Continued)

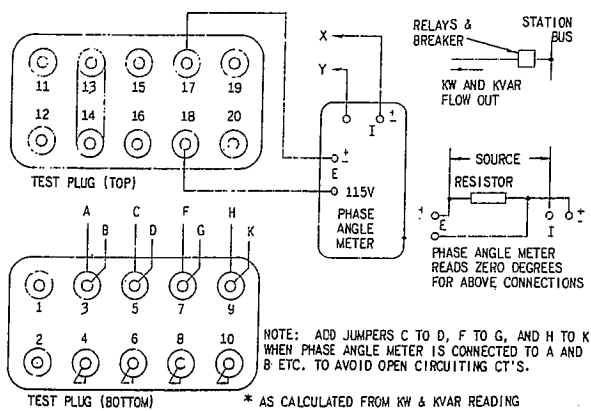

Fig. 15 Test Connections For Overall Test Of Type CEYB12A Relaying Terminal

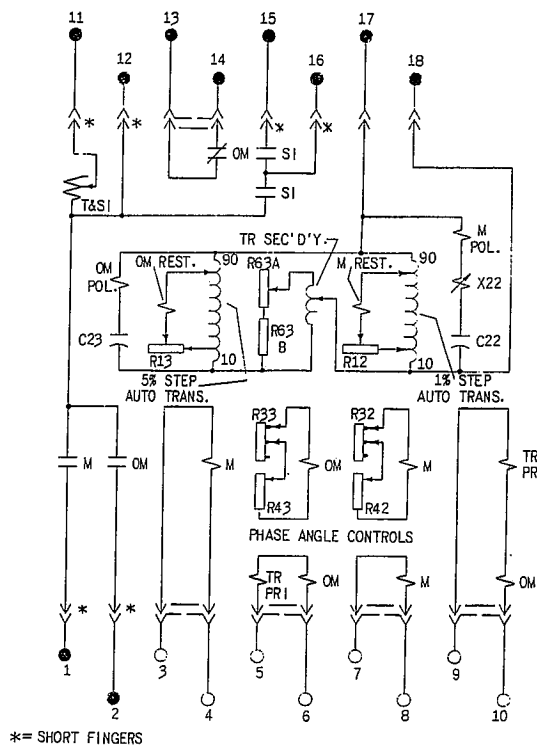

Fig. 16 Internal Connection Diagram For Type CEYB12A Relay (Front View)

CONNECTIONS

The internal connection diagram for the relay is shown in Fig. 16. A typical wiring diagram is given in Fig. 14.

Unless mounted on a steel panel which adequately grounds the relay case, it is recommended that the case be grounded through a mounting stud or screw with a conductor not less than #12 B & S gauge copper wire or its equivalent.

MAINTENANCE

PERIODIC TESTS

The relay should receive an inspection such as described under INSPECTION at least once every

six months, with enough of an electrical test to determine that both units and the seal-in will operate.

FIELD TESTS

Electrical Check Tests on the MHO Units

The manner in which mho unit reach settings are made is briefly discussed in the introduction of these instructions. It is the purpose of the electrical tests in this section to check the ohmic pickup at the settings which have been made for a particular line section.

To eliminate the errors which may result from possible instrument inaccuracies a test circuit has been selected which requires no instruments. Such a circuit is shown in Fig. 17. In Fig. 18 R_S is a current limiting resistance; S_F is the fault switch and $R_L + j X_L$ is the impedance of the line section for which the relay is being tested. The autotransformer, TA, which is across the fault switch and line impedance is tapped in 10 per cent and 1 per cent steps so that the line impedance $R_L + j X_L$ may be made to appear to the relay very nearly as the actual line on which the relay is to be used. This is necessary since it is not feasible to provide the portable test reactor, X_L , and the test resistor, R_L , with enough taps so that the combination may be made to match any line.

For convenience in field testing the fault switch and tapped autotransformer of Fig. 17 have been arranged in a portable test box, Cat. No. 102L201, which is particularly adapted for testing directional and distance relays. The box is provided with terminals to which the relay current and potential circuits as well as the line and source impedances may be readily connected. For a complete description of the test box the user is referred to GEI-38977.

Other equipment required includes:

- Load Box
- Tapped Test Reactor
- Tapped Test Resistor
- Voltmeter
- Ammeter
- Test Plugs

To check the calibration of the mho units it is suggested that the test box Cat. 102L201; test reactor (Cat. 6054975); and test resistor (Cat. 615B546) be arranged with the type XLA12A test plugs as shown in Fig. 18 which is similar to that shown in Fig. 17.

Since the reactance of the test reactor may be very accurately determined from its calibration curve, it is desirable to check relay pickup with the fault reactor alone, due account being taken of the angular difference between the line reactance, X_L , and the relay angle of maximum reach. The line reactance, X_L , selected should be the test reactor

tap nearest above twice the mho unit reach with account being taken of the difference in angle of the test reactor tap impedance and the relay angle of

Fig. 17 (459A261-1)

Fig. 18 (459A266-1)

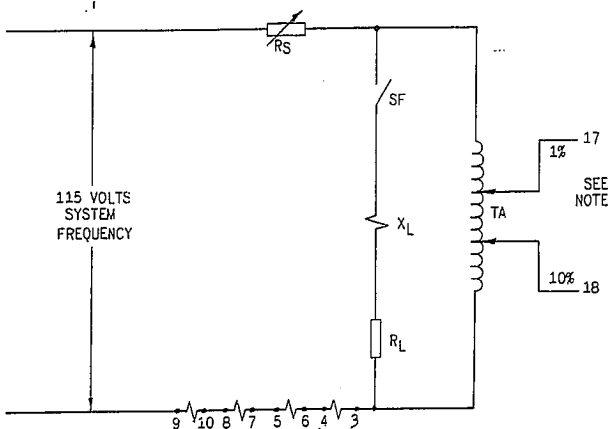

Fig. 17 Schematic Diagram Of CEYB12A Relay Test Connections

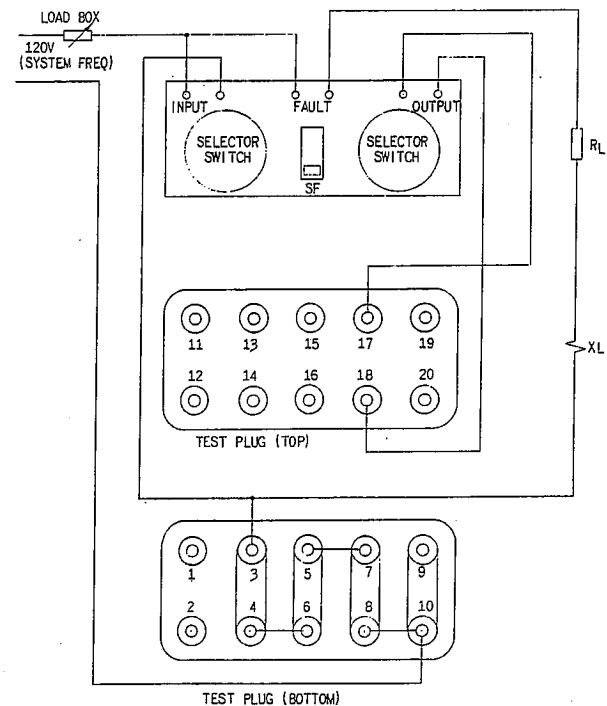

Fig. 18 Test Connections For Type CEYB12A Relay Using Portable Test Box 102L201

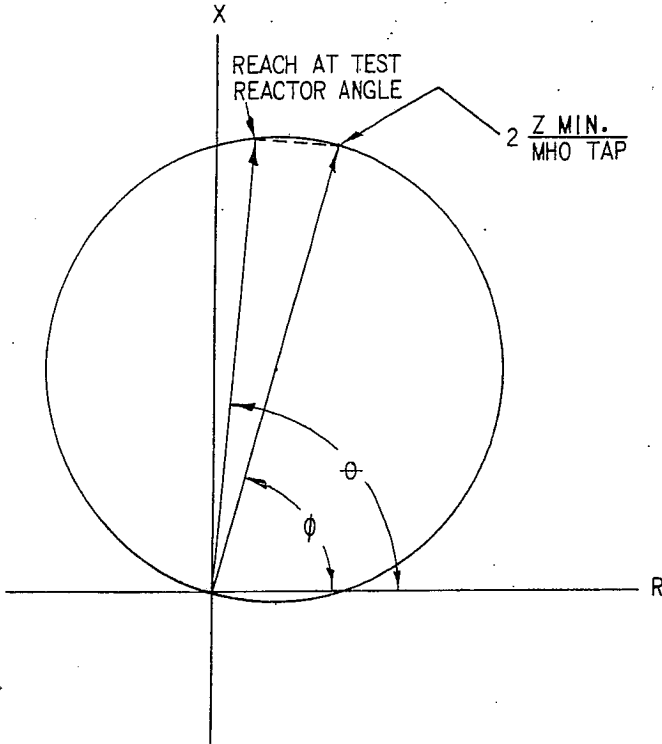

Fig. 19 Reach Of The MHO Unit At The Angle Of The Test Reactor

maximum reach. From Fig. 19 it is seen that twice the relay reach at the angle of the test reactor impedance is:

$$2Z \text{ Relay} = 2 \frac{Z \text{ min. ohms}}{E^2 \text{ tap}} \cos (\theta - \phi)$$

where θ is the angle of the test reactor impedance, ϕ is the relay angle of maximum reach, and E^2 tap is the voltage restraint tap setting expressed as a decimal. The testbox autotransformer percent tap for the mho-unit pickup is given by:

$$\% \text{ tap} = \frac{2Z \text{ Relay}}{Z_L} \quad (100)$$

To illustrate by an example let us consider the percent tap required on the test box autotransformer for an M unit that has been factory adjusted to pick up at 3 ohms minimum at a maximum torque angle of 75 degrees. In determining the reactor tap setting to use it may be assumed that the angle θ of the test impedance is 80 degrees. From the above, twice the relay reach at the angle of the test-reactor impedance is:

$$2Z \text{ relay} = 2 \frac{3}{1.0} \cos (80-75) = 5.96 \text{ ohms}$$

Therefore, use the reactor 6 ohm tap. Twice the relay reach at the angle of test reactor impedance should be recalculated using the actual angle of the reactor tap impedance rather than the assumed 80 degrees. Table III shows the angles for each of the reactor taps.

TABLE III

TAP	ANGLE θ	COS ($\theta - \phi$)
24	88	0.973
12	87	0.976
6	86	0.980
3	85	0.984
2	83	0.989
1	81	0.994
0.5	78	0.988

From the table it is seen that the angle of the impedance of the 6 ohm tap is 86 degrees. Therefore:

$$2Z \text{ relay} = 2 \frac{3}{1.0} \cos (86-75) = 5.87 \text{ ohms}$$

The calibration curve for the portable test reactor should again be referred to in order to determine the exact reactance of the 6 ohm tap at the current level being used. For the purpose of this illustration assume that the reactance is 6.1 ohms. Since the angle of the impedance of the 6 ohm tap is 86 degrees, the impedance of this tap may be calculated as follows:

$$Z_L = \frac{X_L}{\cos 4} = \frac{6.1}{.9976} = 6.115$$

From this calculation it is seen that the reactance and the impedance may be assumed the same for this particular reactor tap. Actually the difference need only be taken into account on the reactor 3, 2, 1 and 0.5 ohm taps.

The test box autotransformer tap setting required to close the mho-unit contacts with the fault switch closed is:

$$\% = \frac{5.87}{6.1} (100) = 96\%$$

If the ohmic pickup of the mho unit checks correctly according to the above, the chances are that the angle of the characteristic is correct. The angle may however, be very easily checked by using the calibrated test resistor in combination with various reactor taps. The calibrated test resistor taps are pre-set in such a manner that when used with 12 or 6 ohm taps of the specified test reactor, impedances at 60 degrees and 30 degrees respectively will be available for checking the mho-unit reach at the 60 degree and 30 degree positions. The mho-unit reach at the zero-degree position may be checked

Fig. 19 (459A262-0)

by using the calibrated test resistor alone as the line impedance. The calibrated test reactor is supplied with a data sheet which gives the exact impedance and angle for each of the combinations available. The test-box autotransformer per cent tap for pickup at a particular angle is given by:

$$\% \text{ Tap} = \frac{2 (3.0) \cos (\theta - 75)}{(E^2 \text{ tap}) Z_L} \times 100$$

where θ is the angle of the test impedance (Z_L), 75° is the angle of the relay characteristic, Z_L is the 60 degree, 30 degree or zero degree impedance value taken from the calibrated resistor data sheet and E^2 is mho unit restraint tap setting expressed as a decimal. As in the case of the previous tests, the load box should be adjusted to allow approximately 10 amperes to flow in the fault circuit when the fault switch is closed.

When checking the angle of maximum reach of the mho unit as indicated above, there are two factors to keep in mind which affect the accuracy of the results. First, when checking the mho unit at angles of more than 30 degrees off the minimum reach position, the error becomes relatively large with phase angle error. This is apparent from Fig. 19 where it is seen, for example, at the zero-degree position that a two or three degree error in phase angle will cause a considerable apparent error in reach.

Second, the effect of the control spring should be considered when testing the OM unit since the mho unit can only have a perfectly circular characteristic when the control-spring torque is negligible. The spring torque on the M unit can be considered negligible. For any normal level of polarizing voltage, the control spring may be neglected. But in testing the OM unit as indicated above it may be necessary to reduce the test box autotransformer tap setting to a point where the voltage supplied to the unit may be relatively low. This reduces the torque level since the polarizing as well as the restraint torque will be low, making the control spring torque no longer negligible. The result of the control spring at low polarizing voltage is to cause the reach of the mho unit to be reduced.

LABORATORY TESTS

For a complete laboratory test, the procedures using the connections of Fig. 13 (C) and described under the adjustments for the two mho units should be followed.

SERVICING

MECHANICAL ADJUSTMENTS

Contact Cleaning

For cleaning the fine silver contacts, a flexible burnishing tool should be used. This consists of a

flexible strip of metal with an etched roughened surface, resembling in effect a superfine file. The polishing action is so delicate that no scratches are left, yet corroded material will be removed rapidly and thoroughly. The flexibility of the tool insures the cleaning of the actual points of contacts.

Fine silver contacts should not be cleaned with knives, files, or abrasive paper or cloth. Knives or files may leave scratches which increase arcing and deterioration of the contacts. Abrasive paper or cloth may leave minute particles of insulating abrasive material in the contacts and thus prevent closing.

The burnishing tool described is included in the standard relay tool kit obtainable from the factory.

Contact Adjustments

Figure 20 illustrates and specifies the contact gaps and other adjustments required to obtain proper operations. The gaps should be set by suitable thickness gages.

The contact gap of the M unit should be 0.020 inches. This should be measured between moving and stationary contact tips and should not include wipe of the stationary contact brush. There should be a 0.010 to 0.015 inch space between the stationary contact brush and the felt pad. If the left-hand stationary contact is replaced, the following precautions should be observed. The brush should be carefully formed so that the silver contact meets its backstop simultaneously along their entire line of contact. The contact brush along with the 0.003 of an inch scraper brush in front of it should be formed so that the contact brush has the minimum initial tension which will produce the required amount of wipe. The adjusting screw for the brushes should not be used for more than one quarter of a turn of effective adjustment.

For the OM unit, the normally open (left) contacts have .050-.065 of an inch gap when open and 0.005 of an inch wipe. The normally closed contacts should have 0.005 of an inch wipe. If the left hand stationary contact is replaced, the same precautions as observed for the M unit should be observed.

Control Spring Adjustments

After the relay has been mounted in the test stand, adjust the M unit control spring as follows: First loosen the set screw on the front of the top pivot support. Then rotate the control spring adjusting arm so as to return the contact arm to the right-hand contact (front view), or the backstop as the case may be, but without supplying enough torque so that the contact would move beyond this position if the stationary contact or backstop were removed. Tighten the set screw permitting approximately 0.010 inch end play to the shaft.

The OM contacts should be adjusted to close at 3 amps with 6 volts applied at the angle of maximum torque.

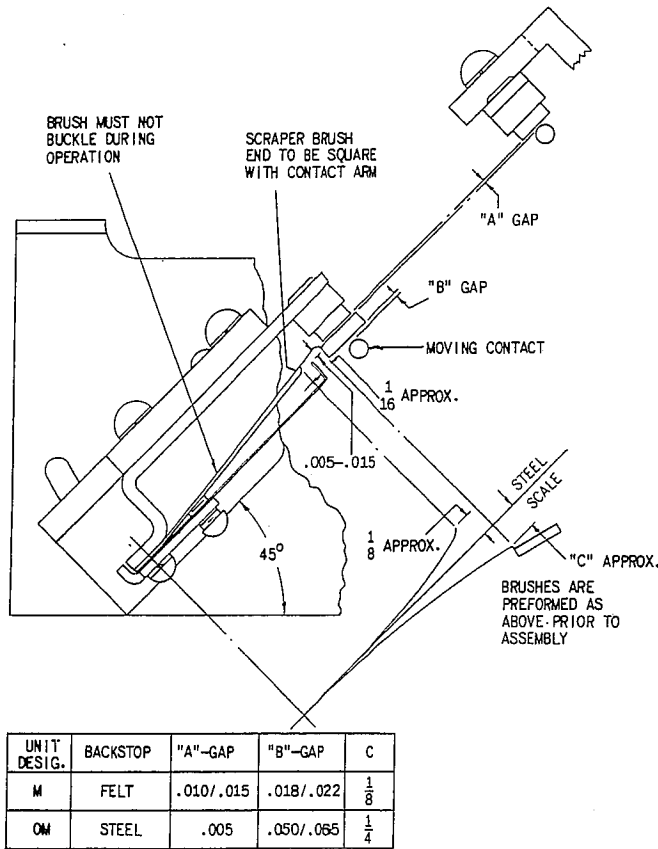

Fig. 20 Contact Adjustments For Type CEYB12A Relay

The M unit clutch should slip at a torque corresponding to approximately 5-7 grams applied at the contact and normal to the contact arm. If it is found that this adjustment has been disturbed, it can be restored by adjusting the steel collar at the upper end of the shaft. Loosen the set screw in the collar and rotate the collar through the number of half turns necessary to obtain the correct pressure. Moving the collar down increases the clutch pressure. The set screw fits into a groove on the shaft which explains the need for half-turn steps.

Note that the M unit clutch slip is limited by a pin on the moving contact arm. A restraint tap setting of 33 percent (9 ohms) or more is necessary to reset the clutch against the 6 gram clutch pressure. Lower restraint tap settings, which are not sufficient to insure clutch resetting, will result in poor contact action, hence longer operating times as described under M UNIT OPERATING CHARACTERISTICS.

The OM unit clutch should slip between 45-60 grams.

RECALIBRATION

Both units are adjusted at the factory for a 75 degree maximum torque angle setting, with the minimum reach setting when the M and

OM taps are on 100 percent. If these angular settings are retained, the relay settings can be made (with approximately 5 per cent accuracy for the M unit setting by using the formulas given under ADJUSTMENTS AND TESTS. If a change in the angular setting of the M or OM units is desired, a test circuit should be set up to measure the impedances at which the relay operates.

M Unit

If the pickup of the M unit is to be set by test, use the connections of Fig. 13 (C). Correct phase angle meter polarity is when the current entering stud 3 and the potential applied to stud 17 are at their positive maximum simultaneously and the phase-angle meter reading is zero. Adjust current, voltage and phase-angle according to the desired ohmic setting and adjust the M taps so that the M contacts will just close but will remain open with a one per cent increase in voltage.

IMPORTANT: The impedance calculated from voltage and current readings with these connections corresponds to phase-to-phase impedance and is double the phase-to-neutral Z_R or Z_L , described previously. When setting for low values of impedance, it is advisable to use approximately 55 volts to avoid excessive currents.

When a phase shifter and phase-angle meter are not available, the circuit of Fig. 13 (B) can be used. The impedance and phase angle of $R_L + jX_L$ must be considered in making an accurate setting.

If it is desired to check the factory setting of the relay use Fig. 13 (C) and current representing 6 ohms, phase-to-phase, lagging the voltage by 75 degrees. If the contacts do not close at the correct current when the M taps are on 100 per cent, the setting of R_{12} should be changed to obtain the correct pick-up current. Raising the slide band decreases the pick-up current.

When cold the unit tends to underreach by 3 or 4 percent; i.e., the M tap setting at which the M unit contacts just close is lower than the normal value. If the relay is permitted to warm up under normal operating conditions with the cover on for 10 minutes, the error due to temperature will be less than one per cent.

If the angular setting is to be checked, use the connections of Fig. 13 (C) with about 55 volts on the relay, and current sufficiently high to cause the contacts to close over a span of 90 degrees or more. Turn the phase shifter and find the two values of phase angle at which the contacts will just close (always taking the reading as contacts move from open to closed position), maintaining the same voltage and current when both angles are read. The angle midway between these two values is the angular setting of the unit, or its angle of maximum operating torque.

The angular setting of the M unit as adjusted at the factory is 75 degrees. If any angular setting is desired within its range, 60 to 75 degrees, the angle

is adjusted by means of R₃₂ plus R₄₂. To reduce the angle from 75 degrees, turn R₄₂ to the left, thereby decreasing the resistance across the floating coil circuit.

Reactor X₂₂ is preset at the factory to obtain a polarizing circuit characteristic angle which provides optimum memory action characteristics. This setting should not be disturbed. If, for any reason, this setting is disturbed, it may be reset as follows:

Remove the jumper connection from R₃₂ and check the angle of maximum torque of the unit as described above. Adjust X₂₂ to obtain a maximum torque angle of 85 degrees lag. Tighten the locknut which locks X₂₂ into place and replace the jumper connection in R₃₂. Any changes made on X₂₂ will necessitate a recheck on angular setting and the pickup of the unit as described above. The reach can be reset by adjusting R₁₂.

OM Unit

The operating element of the OM unit has the same circuit elements as the M unit except it does not contain a reactor corresponding to X₂₂.

The method of angular adjustment is the same as for the M unit. The resistance involved for the OM unit is R₃₃ plus R₄₃.

The ohmic reach can also be adjusted accurately by test using the same procedures as for the M unit by adjusting R₁₃.

The angular setting of the transactor can be changed to match any change in the angular setting of the operating element by means of the resistance R₆₃. Two ohmic characteristic curves similar to Fig. 6 should be plotted, one with offset, and one without offset. Draw the best circle approximating each of the curves and mark the position of their centers. A line joining the centers gives the angle of the offset. To decrease the angle, turn R₆₃ to the left.

When checking the ohmic characteristic curve in the offset direction, apply sufficiently low voltages so that excessive currents are not necessary to cause the unit to pick up. High currents not only cause the unit to overheat but give erroneous results due to transactor saturation. For example, with the one quarter ohmic offset tap, transactor saturation makes it impossible for the unit to operate at the angle of maximum offset reach if the voltage is greater than approximately 25 volts. From an application standpoint, this is of no practical significance since it is only necessary for the transactor to insure high speed operation for zero voltage faults.

RENEWAL PARTS

It is recommended that sufficient quantities of renewal parts be carried in stock to enable the prompt replacement of any that are worn, broken or damaged.

When ordering renewal parts, address the near-

est Sales Office of the General Electric Company, specify quantity required, name of part wanted, and give complete nameplate data including serial number. Refer to publication GEF-4144.

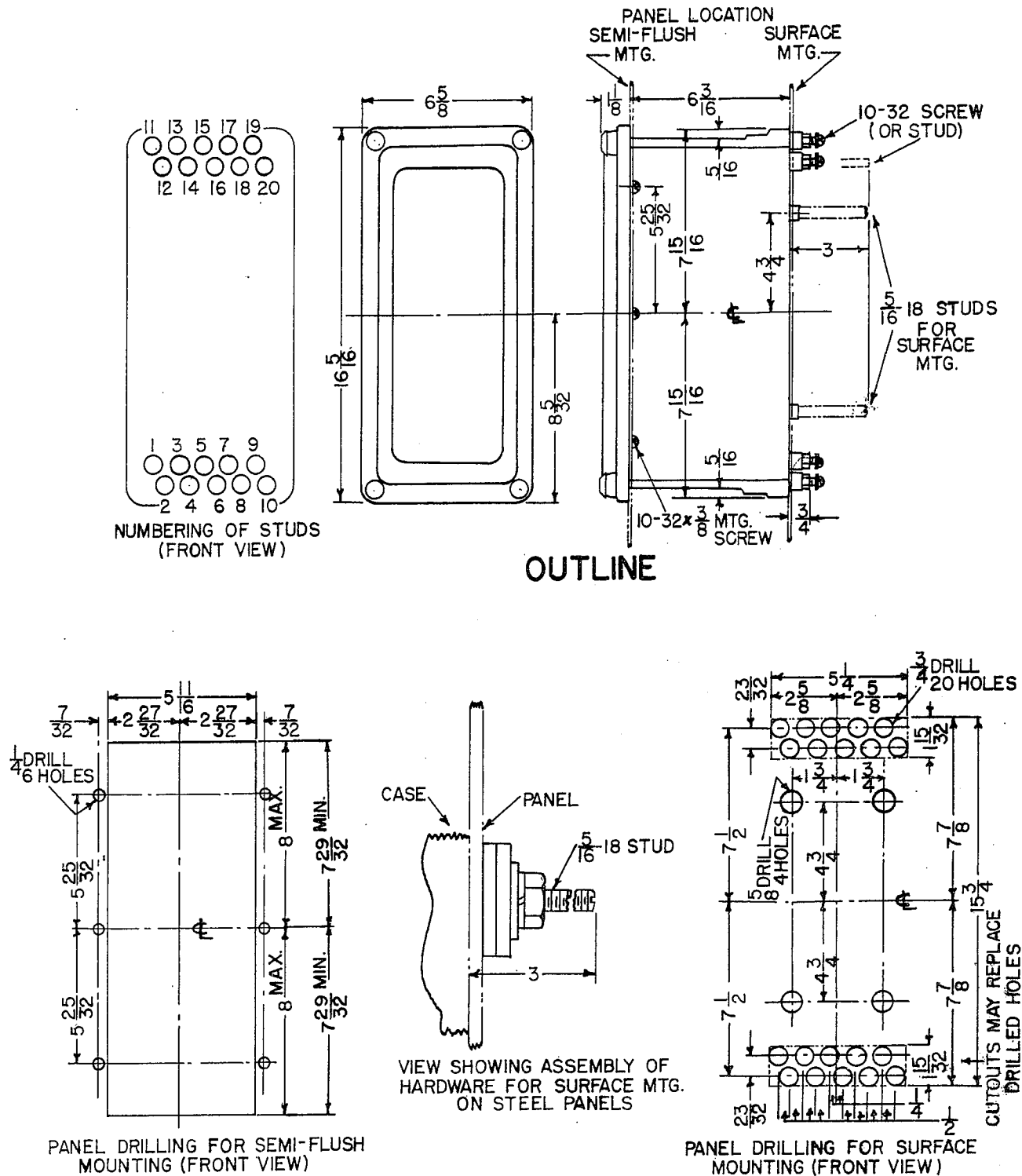

Fig. 21 Outline And Panel Drilling Diagram For Type CEYB12A Relay

Fig. 21 (K-6209274-2)