

101N140
LOCATE ON
CENTER OF
COVER

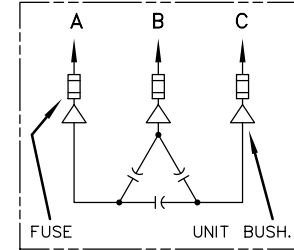
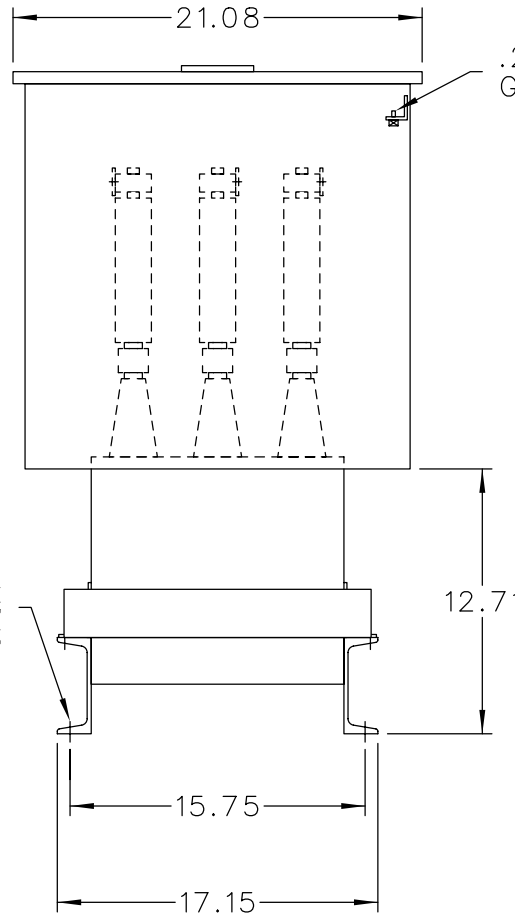
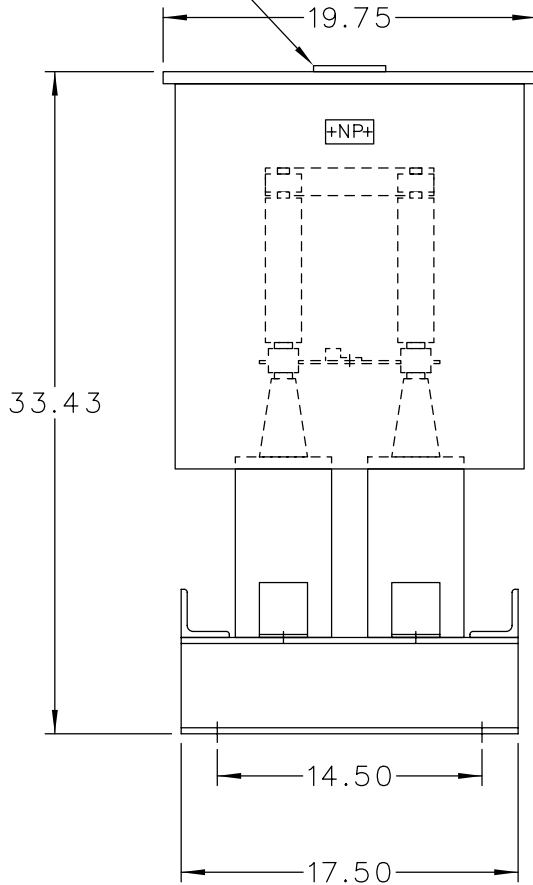

SCHEMATIC DIAGRAM

INCLUDES DISCHARGE RESISTORS

CAT. 37F0521433 SER.NO.
KVAR 250 VOLT 2400
Hz 60 PH 3 CONN. DELTA
CONN. DIAG.

READ INST. GEH-2711

NP220452

NOTE:
ADD "037" SUFFIX TO
CATALOG NO. FOR
CSA LABELED PRODUCT.

 <p>CAPACITOR & POWER PROTECTION FORT EDWARD, N.Y., U.S.A.</p>	<p>SIZE A</p>	<p>APPROX. WT 139 LBS</p>
	<p>DRAWN E.McGINN</p>	<p>MAY 17, 1994</p>
<p>ISSUED</p>		<p>SHEET 2</p>

OUTLINE
37F0521433

DISTR TO