

101N140
LOCATE ON
CENTER OF
COVER

TERMINAL FOR #6
TO 250 MCM CABLE

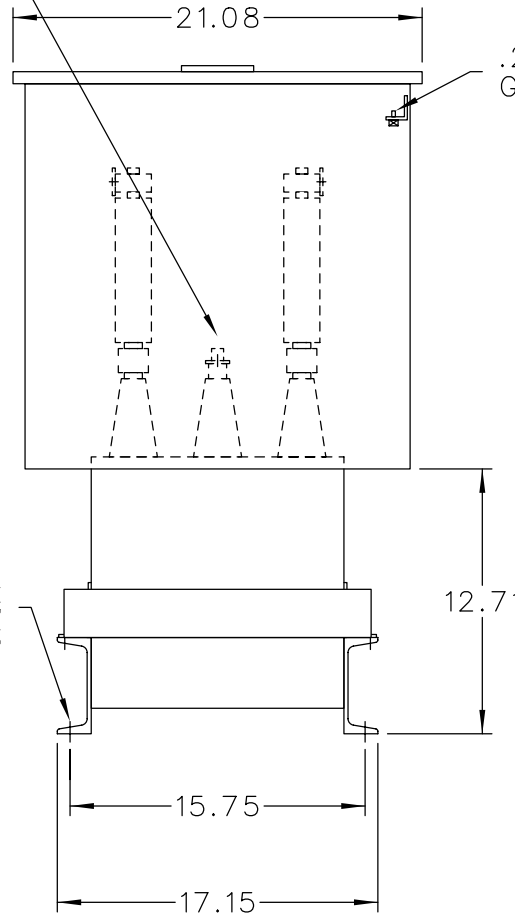

.25-20
GRD SCR.

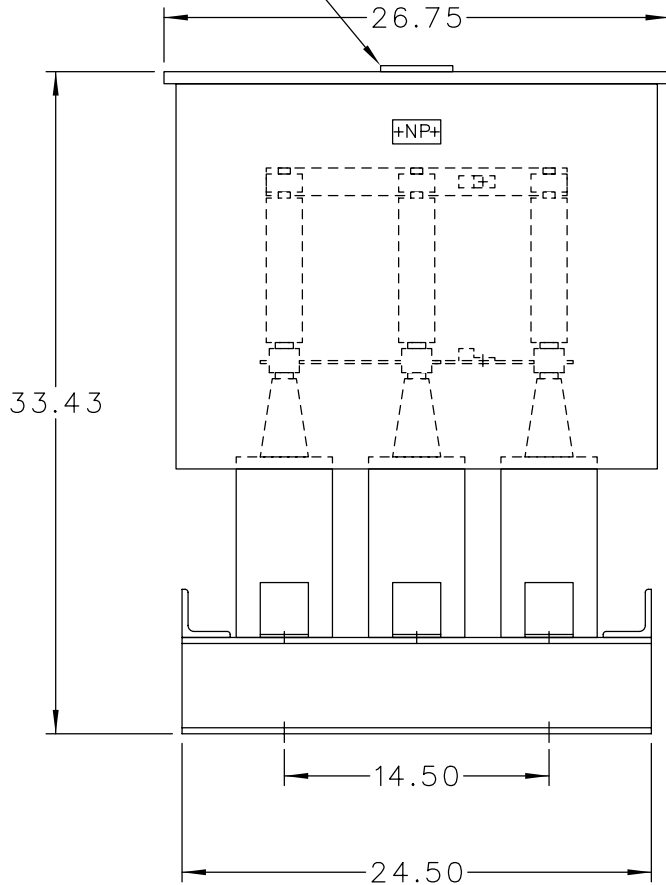
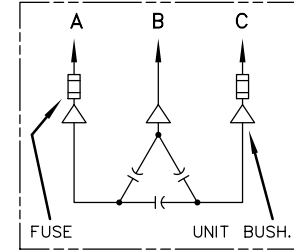

SCHEMATIC DIAGRAM

INCLUDES DISCHARGE RESISTORS

CAT. 37F0522422 SER.NO.
KVAR 575 VOLT 2400
Hz 60 PH 3 CONN. DELTA
CONN. DIAG.

READ INST. GEH-2711

NP220452

NOTE:
ADD "037" SUFFIX TO
CATALOG NO. FOR
CSA LABELED PRODUCT.

	CAPACITOR & POWER PROTECTION FORT EDWARD, N.Y., U.S.A.	
	DRAWN E.McGINN	FEB. 12, 1993
ISSUED	SCALE	

SIZE A	APPROX.WT 248 LBS
SCALE	

OUTLINE 37F0522422	SHEET 2
DISTR TO	