

101N140
LOCATE ON
CENTER OF
COVER

TWO TERMINALS FOR #6 TO
250 MCM CABLE PER PHASE

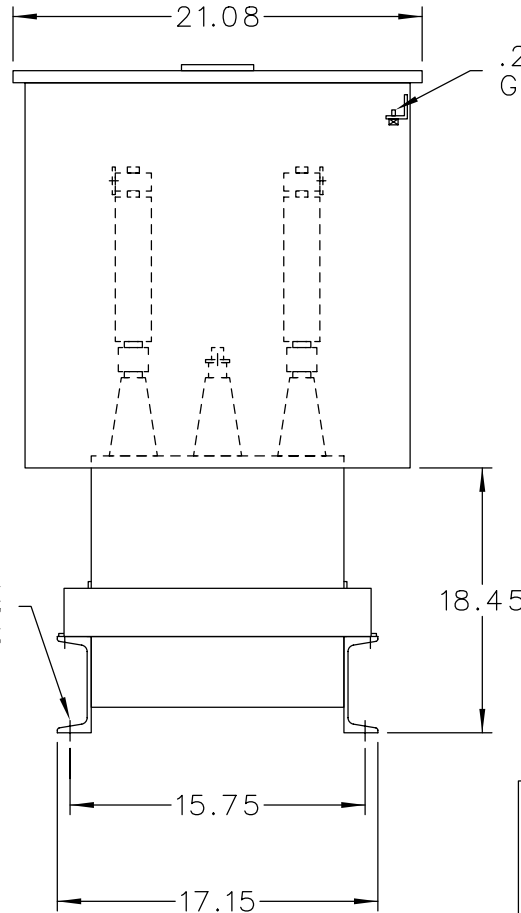

.25-20
GRD SCR.

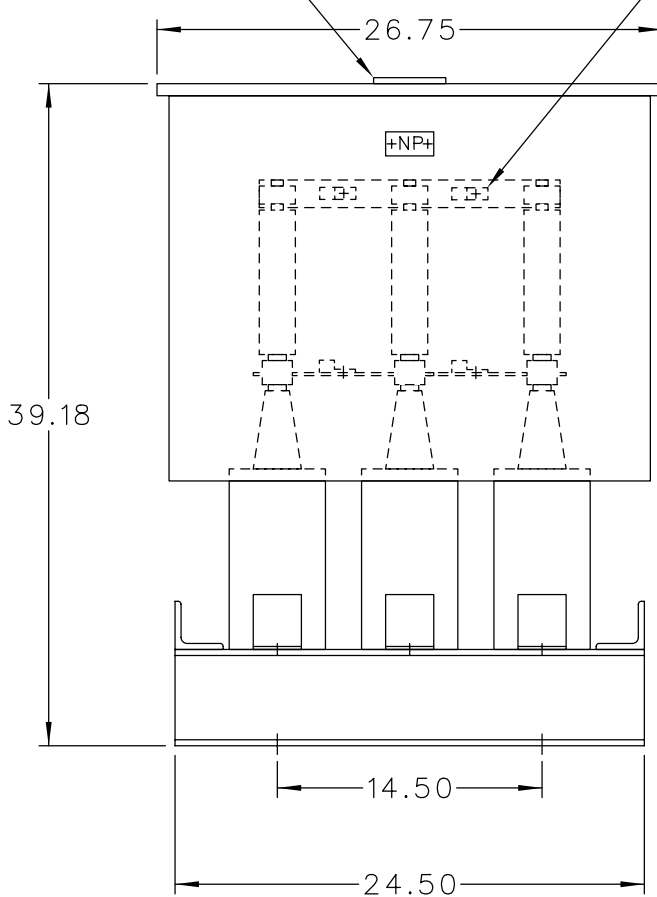
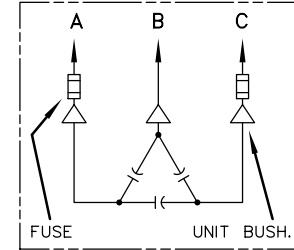

SCHEMATIC DIAGRAM

INCLUDES DISCHARGE RESISTORS

CAT. 37F0522429 SER.NO.
KVAR 775 VOLT 2400
Hz 60 PH 3 CONN. DELTA
CONN. DIAG.

READ INST. GEH-2711

NP220452

NOTE:
ADD "037" SUFFIX TO
CATALOG NO. FOR
CSA LABELED PRODUCT.

	CAPACITOR & POWER PROTECTION FORT EDWARD, N.Y., U.S.A.	
	DRAWN JCozzens	JULY 29, 1997
ISSUED	SCALE	

SIZE A	APPROX. WT 309 LBS
SCALE	

OUTLINE 37F0522429	SHEET 2
DISTR TO	