

101N140  
LOCATE ON  
CENTER OF  
COVER

TWO TERMINALS FOR #6 TO  
250 MCM CABLE PER PHASE

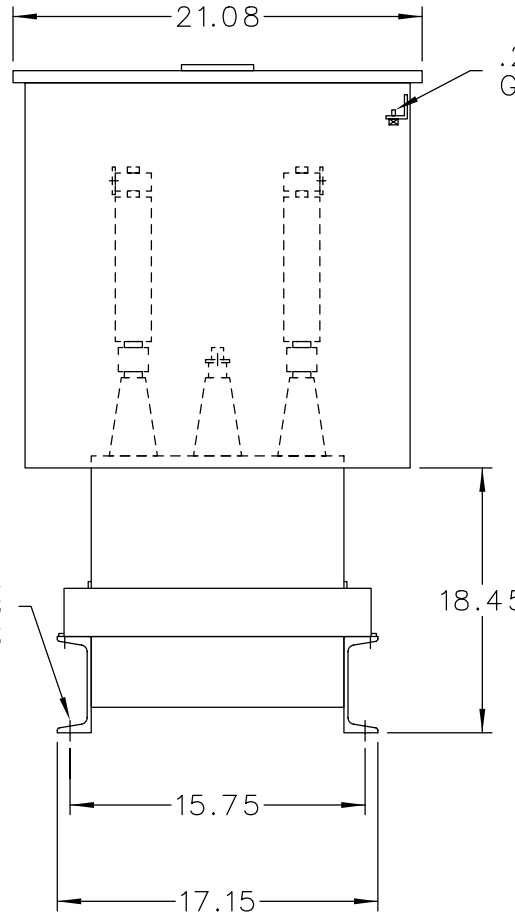

.25-20  
GRD SCR.

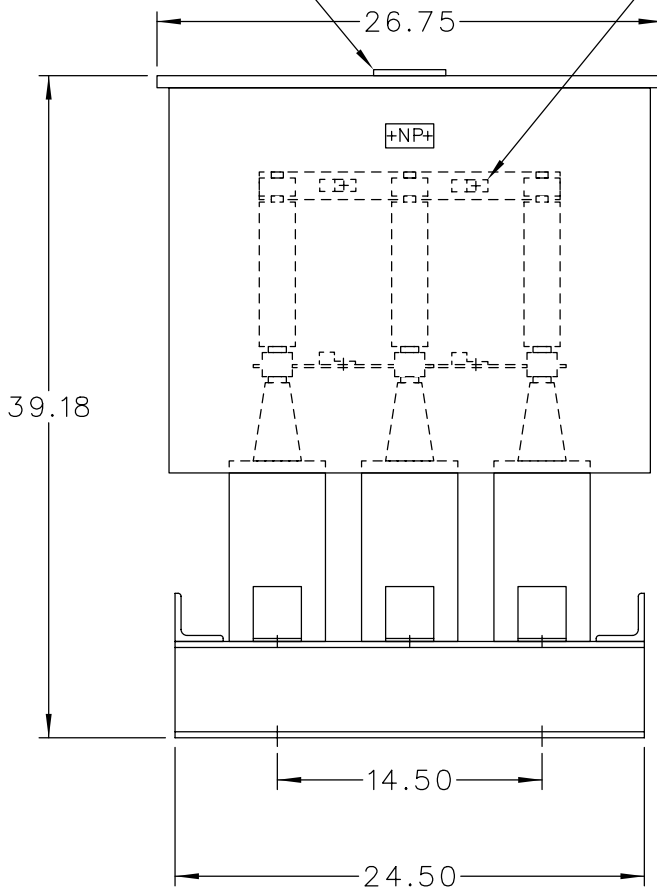
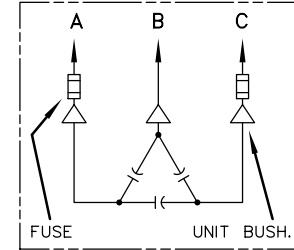

SCHEMATIC DIAGRAM

INCLUDES DISCHARGE RESISTORS

CAT. 37F0522430 SER.NO.  
KVAR 800 VOLT 2400  
Hz 60 PH 3 CONN. DELTA  
CONN. DIAG.

READ INST. GEH-2711

NP220452

NOTE:  
ADD "037" SUFFIX TO  
CATALOG NO. FOR  
CSA LABELED PRODUCT.

	CAPACITOR & POWER PROTECTION FORT EDWARD, N.Y., U.S.A.	
	DRAWN JCozzens	JULY 29, 1997
ISSUED	SCALE	

SIZE <b>A</b>	APPROX. WT 320 LBS
SCALE	

OUTLINE <b>37F0522430</b>	SHEET 2
DISTR TO	