

SIZE A	DWG NO. 37F0523332	SH 2	REV
REV	NEW 6/19/86	DATE	
1	HODGES/UPDATE	13R-89 48	

SOLDERLESS CONN.
FOR #10 SOLID TO
#4 STR'D COND.

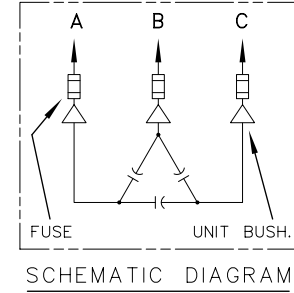
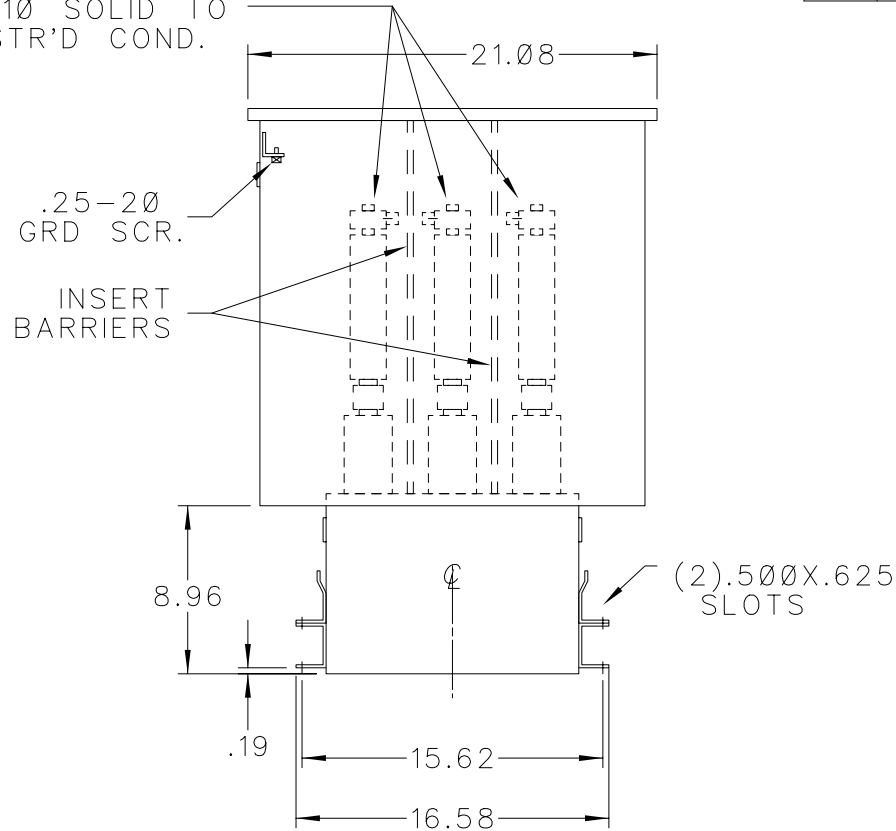
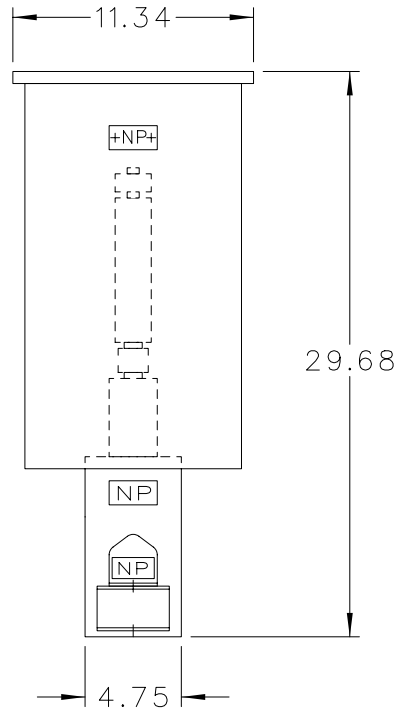

CAT. 37F0523332 SER.NO.
KVAR 50 VOLT 4160
Hz 60 PH 3 CONN. DELTA
CONN. DIAG.

READ INST. GEH-2711

NP220452

NOTE:
ADD "Ø37" SUFFIX TO
CATALOG NO. FOR
CSA LABELED PRODUCT.

GENERAL  ELECTRIC	
CAP. & PWR PROTECTION OPER. LCTN: HUDSON FALLS NY	
DRAWN R.HODGES JUNE 12, 1986	
ISSUED	

SIZE A	APPROX.WT 86 LBS
SCALE	13R-85-182

OUTLINE
37F0523332

SHEET 2

DISTR TO