

SOLDERLESS CONN.
FOR #10 SOLID TO
#4 STR'D COND.

CONNECTION
FOR USER
SUPPLIED
120V POWER

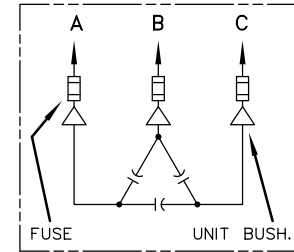
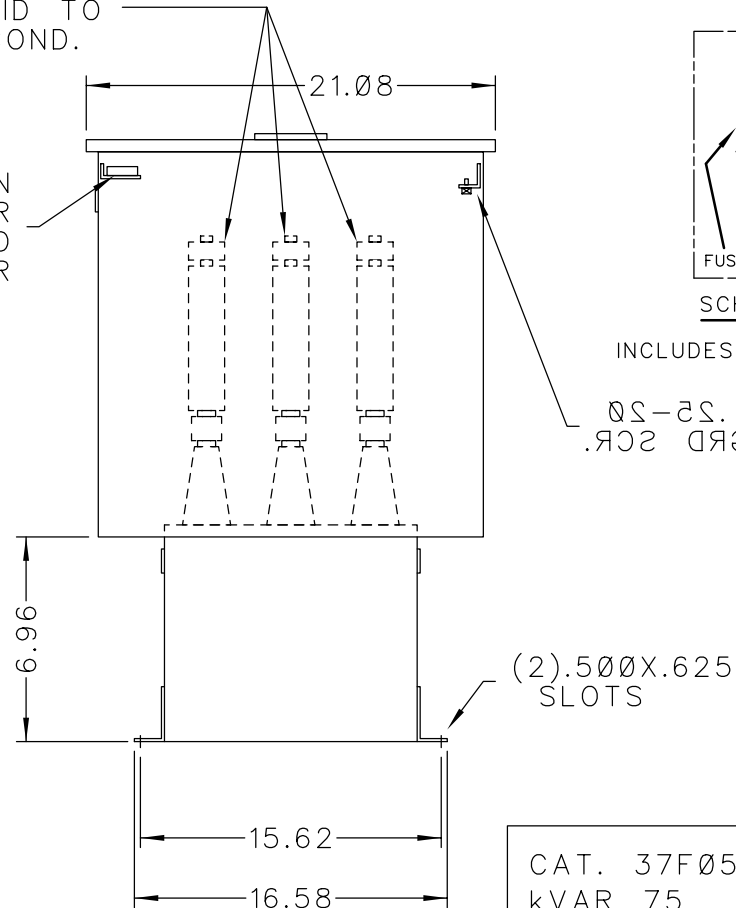

SCHEMATIC DIAGRAM

INCLUDES DISCHARGE RESISTORS

0.5-50.
GRD SCR.

CAT. 37F0523533 SER.NO.
kVAR 75 Hz 60 Ph 3
VOLT 4160 CONN. DELTA
DIAG
NP220452
GEH-2711

NOTE:
ADD "037" SUFFIX TO
CATALOG NO. FOR
CSA LABELED PRODUCT.

 <p>CAPACITOR & POWER PROTECTION FORT EDWARD, N.Y., U.S.A.</p>	SIZE A	APPROX.WT 64 LBS
	DRAWN E.McGINN ISSUED	SEPT. 16, 1998 SCALE

OUTLINE
37F0523533