

TERMINAL FOR #6
TO 25Ø MCM CABLE

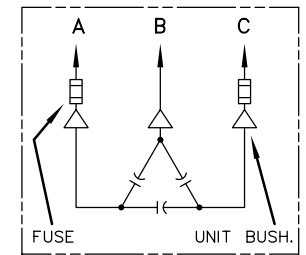
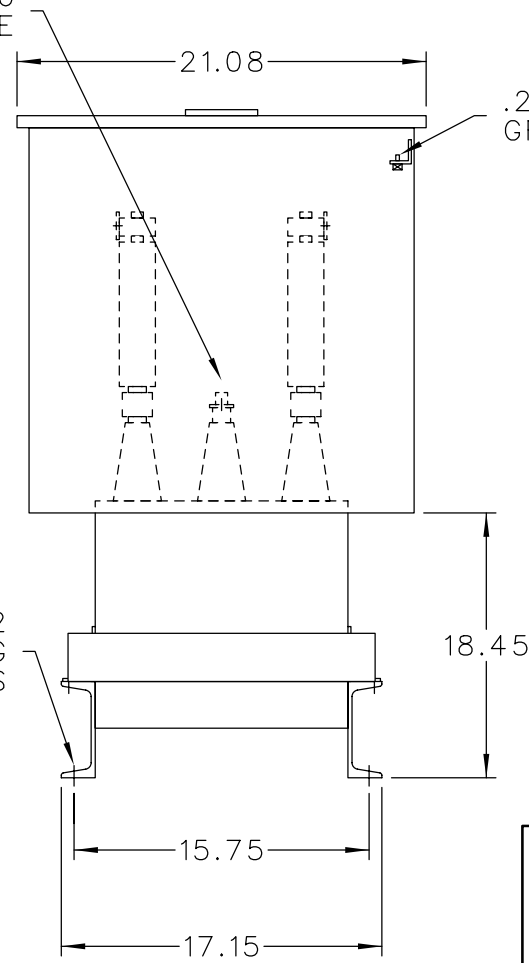

SCHEMATIC DIAGRAM

INCLUDES DISCHARGE RESISTORS

CAT. 37F0524420 SER.NO.
KVAR 425 VOLT 416Ø
Hz 6Ø PH 3 CONN. DELTA
CONN. DIAG.

READ INST. GEH-2711

NP22Ø452

NOTE:
ADD "Ø37" SUFFIX TO
CATALOG NO. FOR
CSA LABELED PRODUCT.

<p>CAPACITOR & POWER PROTECTION FORT EDWARD, N.Y., U.S.A.</p>	<p>DRAWN JCozzens</p>	<p>JULY 28, 1997</p>
	<p>ISSUED</p>	<p>SCALE</p>

SIZE
A

OUTLINE
37F0524420

SHEET 2

DISTR TO