

TERMINAL FOR #6
TO 25Ø MCM CABLE

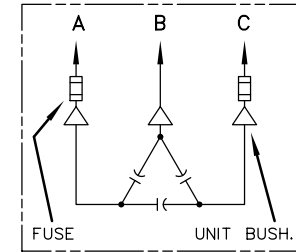
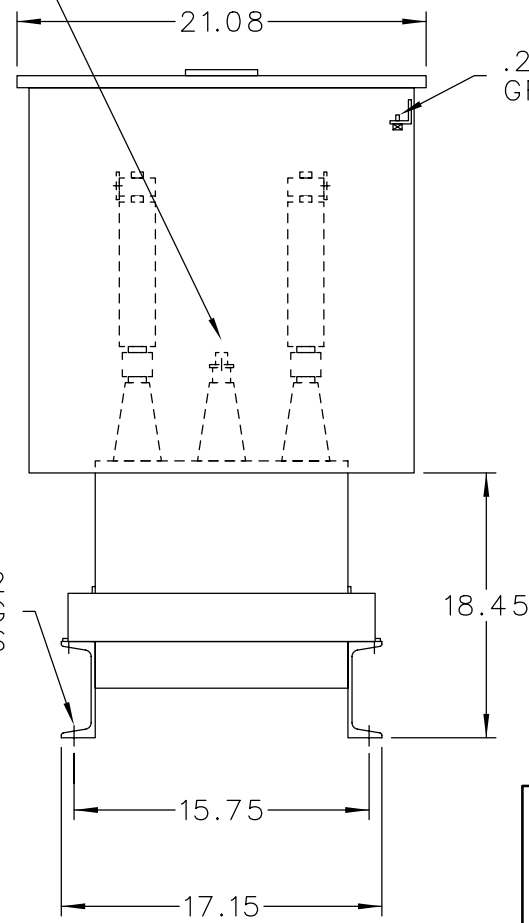

SCHEMATIC DIAGRAM

INCLUDES DISCHARGE RESISTORS

CAT. 37F0524421 SER.NO.
KVAR 450 VOLT 416Ø
Hz 6Ø PH 3 CONN. DELTA
CONN. DIAG.

READ INST. GEH-2711

NP22Ø452

NOTE:
ADD "Ø37" SUFFIX TO
CATALOG NO. FOR
CSA LABELED PRODUCT.

	CAPACITOR & POWER PROTECTION FORT EDWARD, N.Y., U.S.A.	
	DRAWN JCozzens	JULY 28, 1997
ISSUED	SCALE	

SIZE A	APPROX. WT 192 LBS
SCALE	

OUTLINE 37F0524421
SHEET 2

DISTR TO