

101N140
LOCATE ON
CENTER OF
COVER

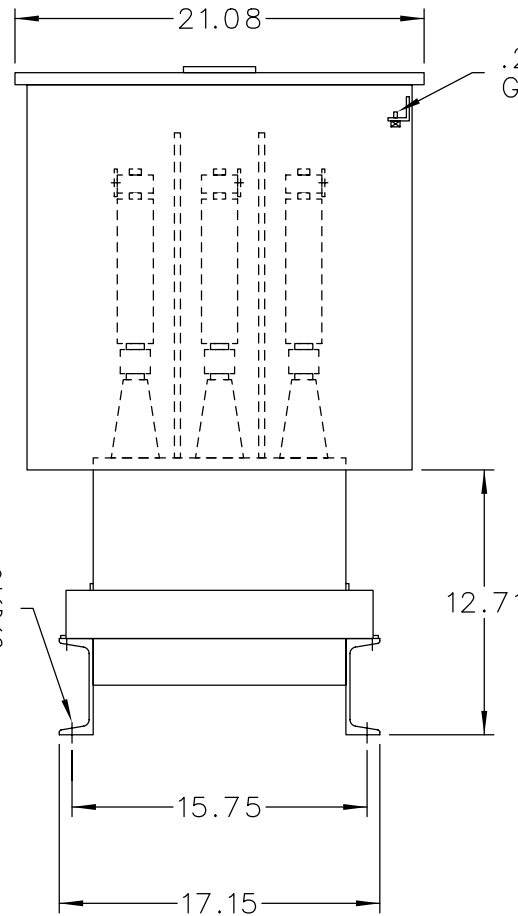

.25-20
GRD SCR.

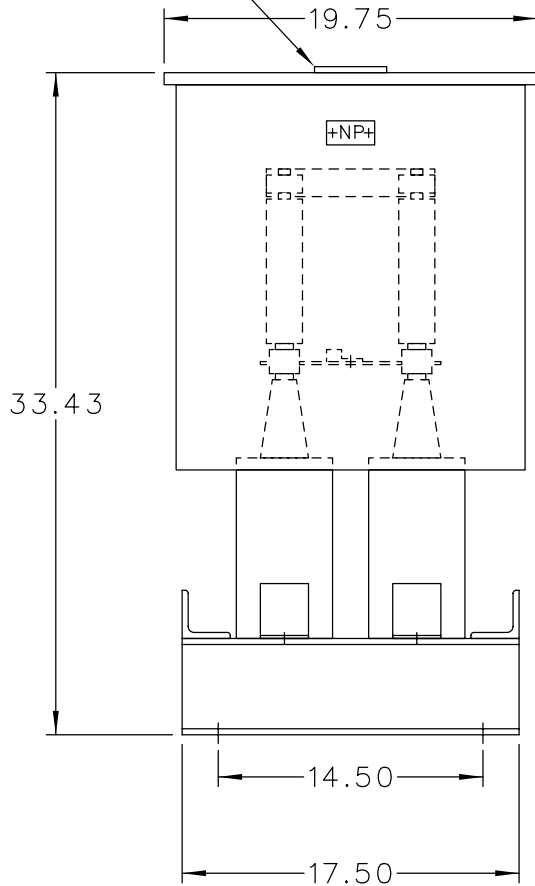
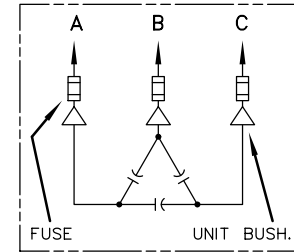

SCHEMATIC DIAGRAM

INCLUDES DISCHARGE RESISTORS

CAT. 37F0524435 SER.NO.
KVAR 300 VOLT 4160
Hz 60 PH 3 CONN. DELTA
CONN. DIAG.

READ INST. GEH-2711

NP220452

NOTE:
ADD "037" SUFFIX TO
CATALOG NO. FOR
CSA LABELED PRODUCT.

 CAPACITOR & POWER PROTECTION FORT EDWARD, N.Y., U.S.A.	SIZE A	APPROX. WT 149 LBS
	DRAWN E.McGINN ISSUED	MAY 17, 1994 SCALE

OUTLINE
37F0524435

SHEET 2

DISTR TO