

1Ø1N14Ø
LOCATE ON
CENTER OF
COVER

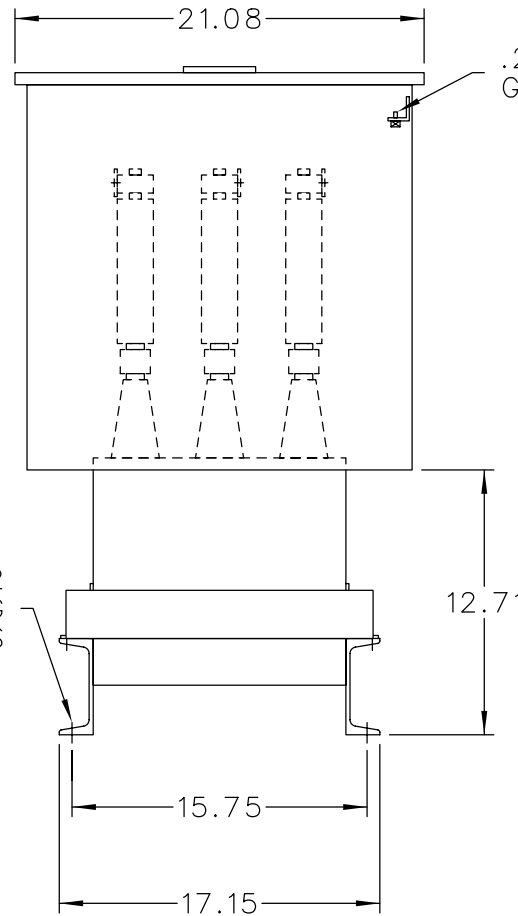

.25-20
GRD SCR.

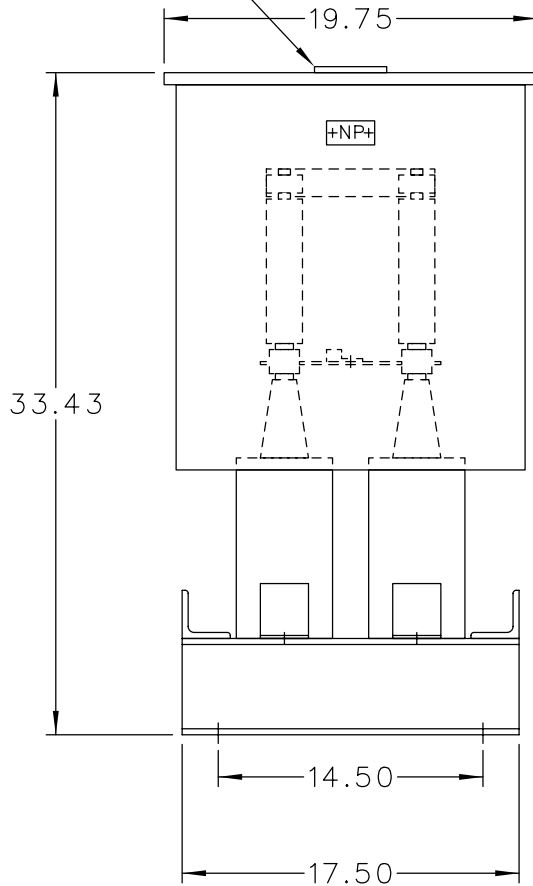
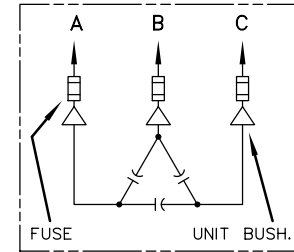

SCHEMATIC DIAGRAM

INCLUDES DISCHARGE RESISTORS

CAT. 37F0524437 SER.NO.
KVAR 350 VOLT 416Ø
Hz 6Ø PH 3 CONN. DELTA
CONN. DIAG.

READ INST. GEH-2711

NP22Ø452

NOTE:
ADD "Ø37" SUFFIX TO
CATALOG NO. FOR
CSA LABELED PRODUCT.

	CAPACITOR & POWER PROTECTION FORT EDWARD, N.Y., U.S.A.	
	DRAWN E.McGINN	MAY 17, 1994
ISSUED	5-18-94	

SIZE A	APPROX.WT 159 LBS
SCALE	

OUTLINE 37F0524437
SHEET 2

DISTR TO