

101N140  
LOCATE ON  
CENTER OF  
COVER

TERMINAL FOR #6  
TO 250 MCM CABLE

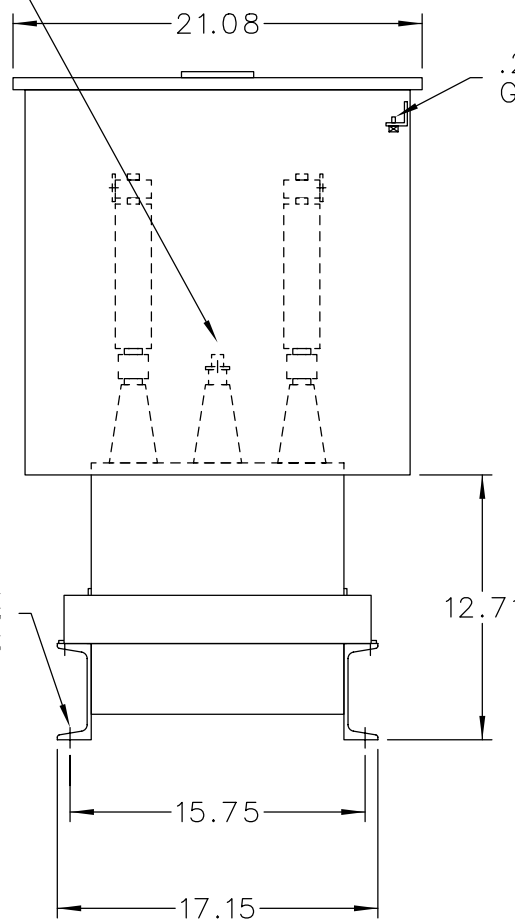

.25-20  
GRD SCR.

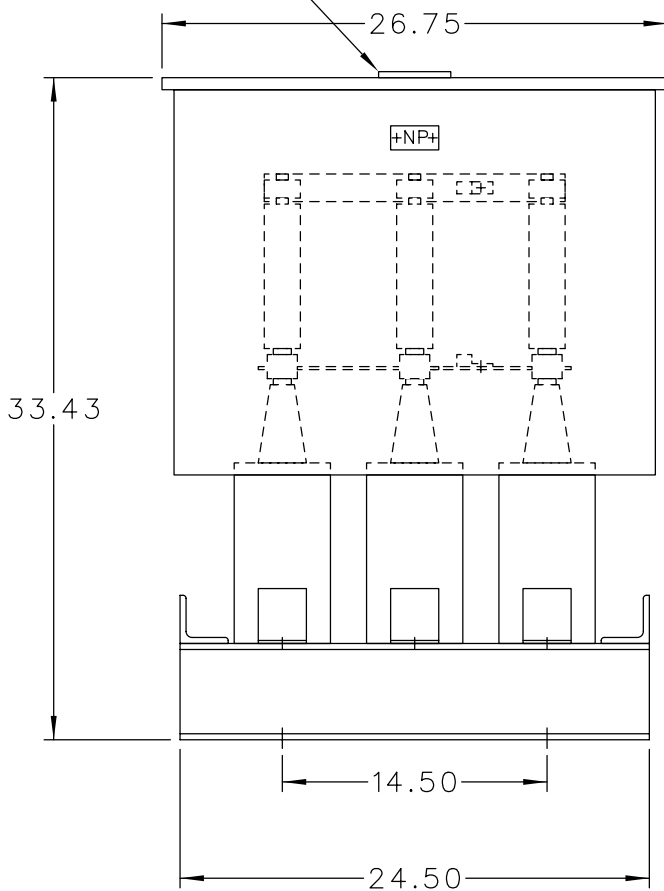
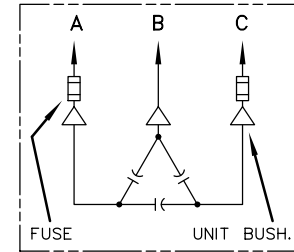

SCHEMATIC DIAGRAM

INCLUDES DISCHARGE RESISTORS

CAT. 37F0525420 SER.NO.  
KVAR 550 VOLT 4160  
Hz 60 PH 3 CONN. DELTA  
CONN. DIAG.

READ INST. GEH-2711

NP220452

NOTE:  
ADD "037" SUFFIX TO  
CATALOG NO. FOR  
CSA LABELED PRODUCT.

	CAPACITOR & POWER PROTECTION FORT EDWARD, N.Y., U.S.A.	
	DRAWN E.McGINN	MAR. 24, 1993
ISSUED	SCALE	

SIZE <b>A</b>	APPROX.WT 242 LBS
SCALE	

OUTLINE <b>37F0525420</b>	SHEET 2
DISTR TO	