

TERMINAL FOR #6  
TO 250 MCM CABLE

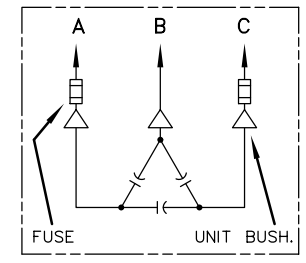
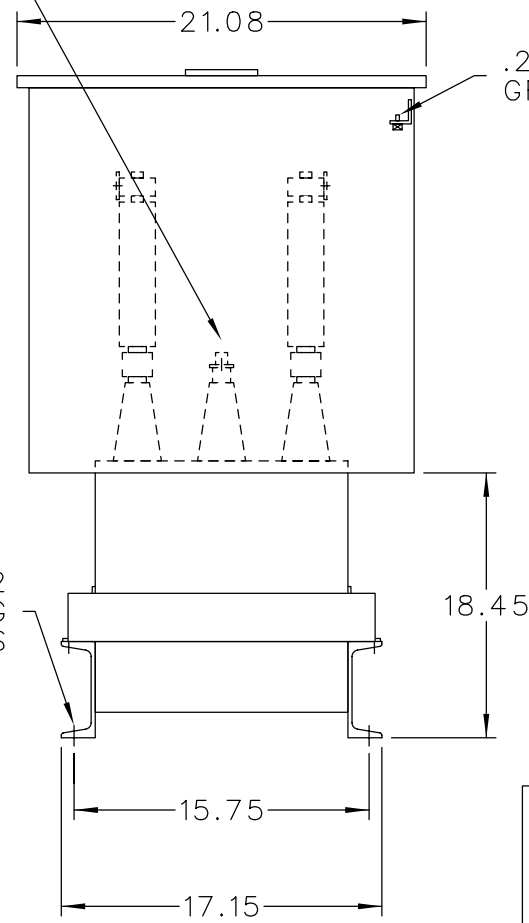

SCHEMATIC DIAGRAM

INCLUDES DISCHARGE RESISTORS

CAT. 37F0525427 SER.NO.  
KVAR 725 VOLT 4160  
Hz 60 PH 3 CONN. DELTA  
CONN. DIAG.

READ INST. GEH-2711

NP220452

NOTE:  
ADD "037" SUFFIX TO  
CATALOG NO. FOR  
CSA LABELED PRODUCT.

<p>CAPACITOR &amp; POWER PROTECTION FORT EDWARD, N.Y., U.S.A.</p>	SIZE <b>A</b>	APPROX. WT 298 LBS
	SCALE	
DRAWN JCozzens	JULY 28, 1997	
ISSUED		

OUTLINE  
37F0525427