

TERMINAL FOR #6
TO 250 MCM CABLE

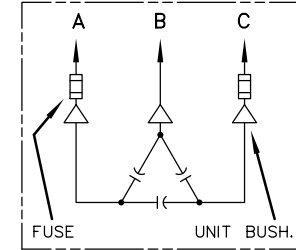
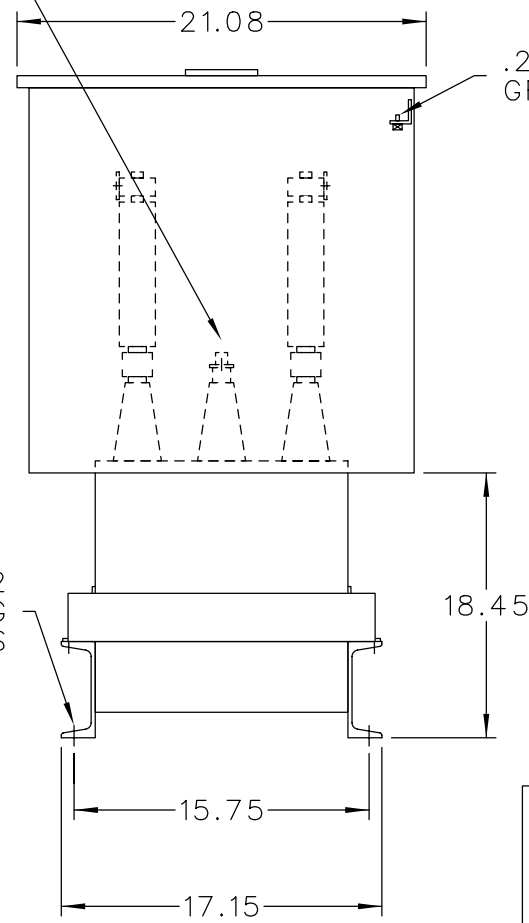

SCHEMATIC DIAGRAM

INCLUDES DISCHARGE RESISTORS

CAT. 37F0525430 SER.NO.
KVAR 800 VOLT 4160
Hz 60 PH 3 CONN. DELTA
CONN. DIAG.

READ INST. GEH-2711

NP220452

NOTE:
ADD "037" SUFFIX TO
CATALOG NO. FOR
CSA LABELED PRODUCT.

 CAPACITOR & POWER PROTECTION FORT EDWARD, N.Y., U.S.A.	SIZE A	APPROX. WT 320 LBS
	DRAWN JCozzens ISSUED	
JULY 28, 1997		

OUTLINE
37F0525430