

TERMINAL FOR #6
TO 250 MCM CABLE

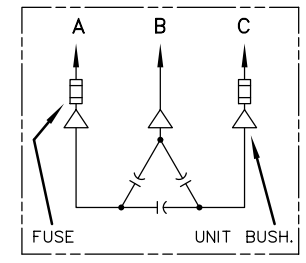
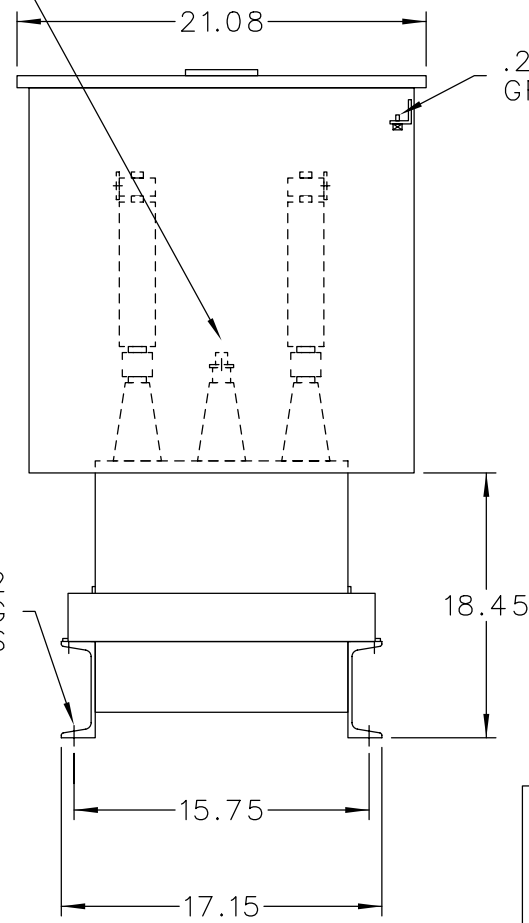

SCHEMATIC DIAGRAM

INCLUDES DISCHARGE RESISTORS

CAT. 37F0525434 SER.NO.
KVAR 900 VOLT 4160
Hz 60 PH 3 CONN. DELTA
CONN. DIAG.

READ INST. GEH-2711

NP220452

NOTE:
ADD "037" SUFFIX TO
CATALOG NO. FOR
CSA LABELED PRODUCT.

<p>CAPACITOR & POWER PROTECTION FORT EDWARD, N.Y., U.S.A.</p>	<p>SIZE A</p>	<p>APPROX. WT 331 LBS</p>
	<p>DRAWN JCozzens</p>	
<p>ISSUED</p>	<p>JULY 28, 1997</p>	<p>SHEET 2</p>

OUTLINE
37F0525434

DISTR TO