

CONNECTION
FOR USER
SUPPLIED
120V POWER

BLOWN FUSE
INDICATING
LIGHTS

TERMINAL FOR
#6 TO 250
MCM CABLE

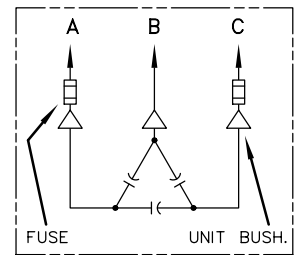
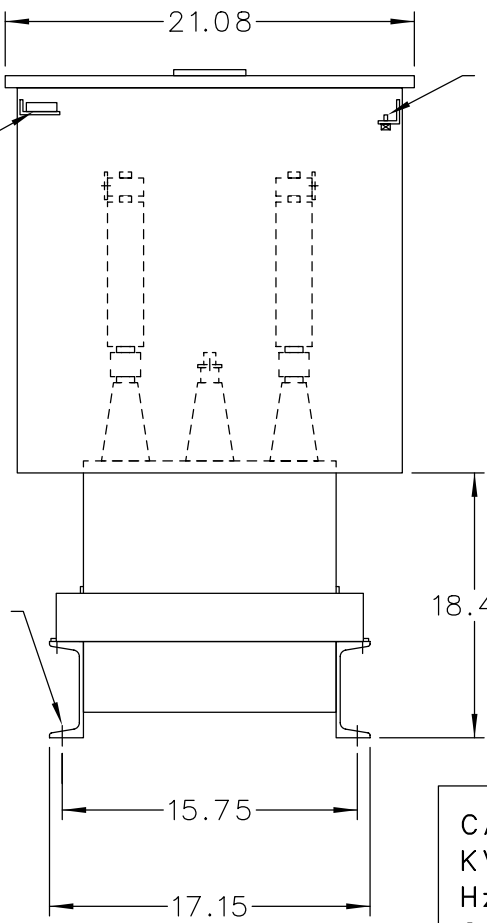

SCHEMATIC DIAGRAM

INCLUDES DISCHARGE RESISTORS

CAT. 37F0525527 SER.NO.
KVAR 725 VOLT 4160
Hz 60 PH 3 CONN. DELTA
CONN. DIAG.

READ INST. GEH-2711

NP220452

NOTE:
ADD "037" SUFFIX TO
CATALOG NO. FOR
CSA LABELED PRODUCT.

	CAPACITOR & POWER PROTECTION FORT EDWARD, N.Y., U.S.A.	
	DRAWN E.McGINN	OCT. 21, 1998
ISSUED	SCALE	

SIZE A	APPROX. WT 298 LBS
SCALE	

OUTLINE 37F0525527	SHEET 2
DISTR TO	