

CONNECTION
FOR USER
SUPPLIED
120V POWER

BLOWN FUSE
INDICATING
LIGHTS

TERMINAL FOR
#6 TO 250
MCM CABLE

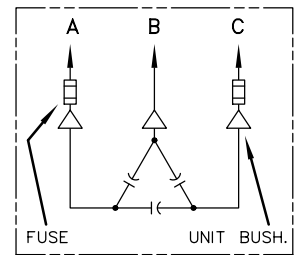
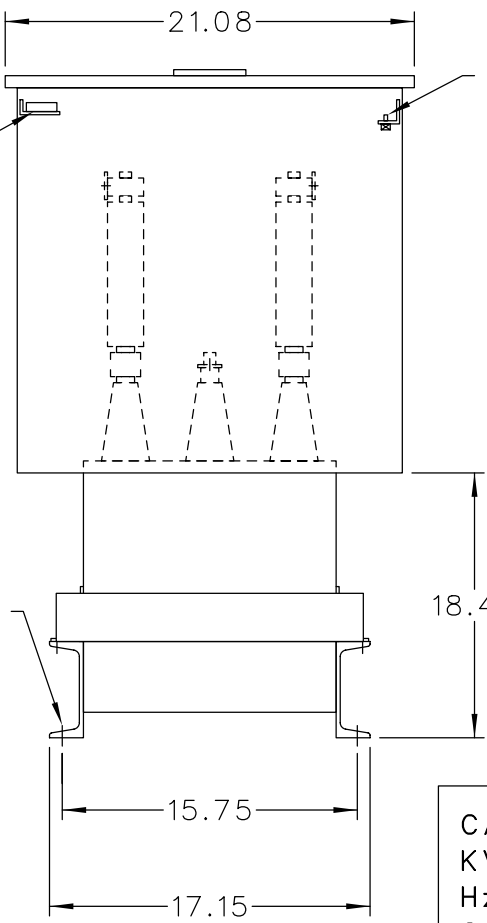

SCHEMATIC DIAGRAM

INCLUDES DISCHARGE RESISTORS

CAT. 37F0525530 SER. NO.
KVAR 800 VOLT 4160
Hz 60 PH 3 CONN. DELTA
CONN. DIAG.

READ INST. GEH-2711

NP220452

NOTE:
ADD "037" SUFFIX TO
CATALOG NO. FOR
CSA LABELED PRODUCT.

	CAPACITOR & POWER PROTECTION FORT EDWARD, N.Y., U.S.A.	
	DRAWN E. McGINN	OCT. 22, 1998
ISSUED	SCALE	SHEET 2

SIZE A	APPROX. WT 320 LBS
SCALE	SHEET 2

OUTLINE
37F0525530

DISTR TO