

TERMINAL FOR #6
TO 25Ø MCM CABLE

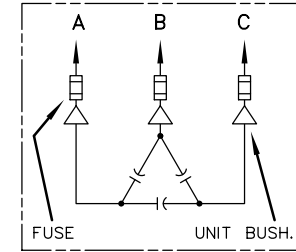
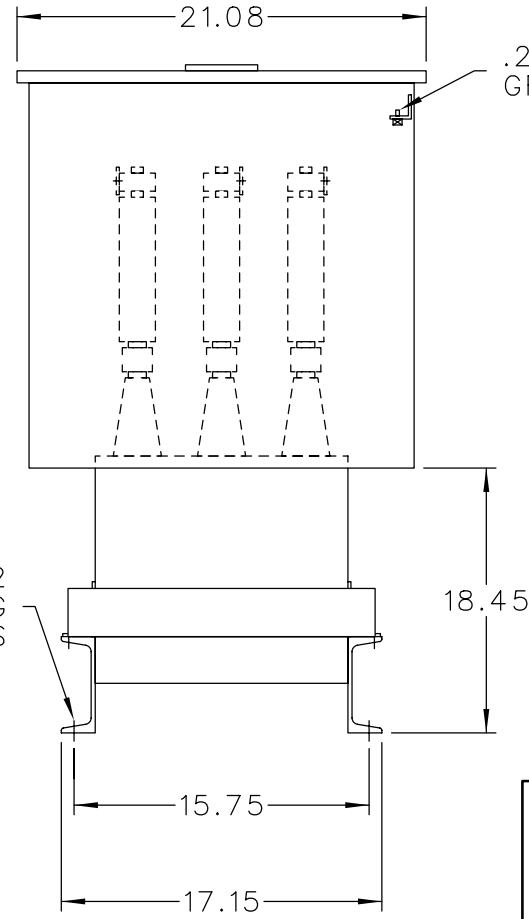

SCHEMATIC DIAGRAM

INCLUDES DISCHARGE RESISTORS

CAT. 37F0527448 SER.NO.
KVAR 575 VOLT 480Ø
Hz 6Ø PH 3 CONN. DELTA
CONN. DIAG.

READ INST. GEH-2711

NP22Ø452

NOTE:
ADD "Ø37" SUFFIX TO
CATALOG NO. FOR
CSA LABELED PRODUCT.

 CAPACITOR & POWER PROTECTION FORT EDWARD, N.Y., U.S.A.	SIZE A	APPROX. WT 214 LBS
	SCALE	
DRAWN JCozzens	JULY 3Ø, 1997	
ISSUED	8-6-97	

OUTLINE
37F0527448