

TERMINAL FOR #6
TO 250 MCM CABLE

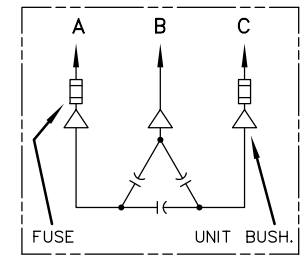
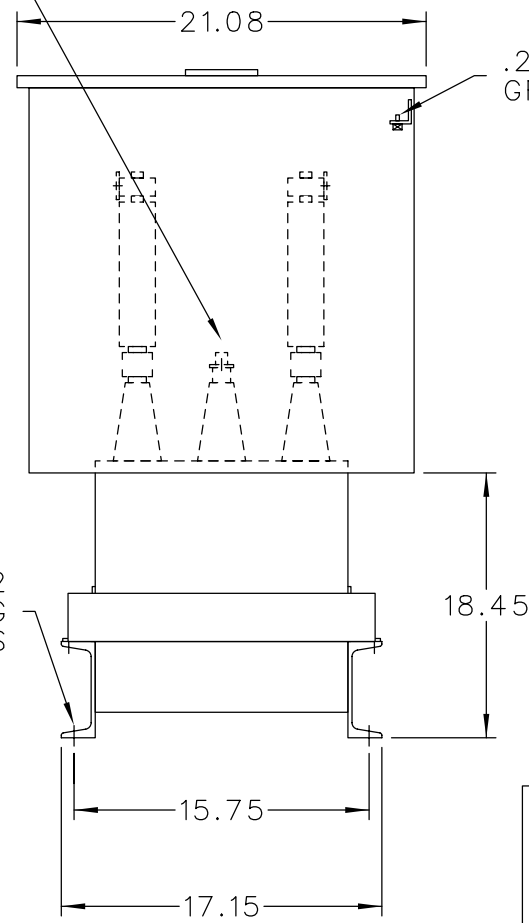

SCHEMATIC DIAGRAM

INCLUDES DISCHARGE RESISTORS

CAT. 37F0528422 SER.NO.
KVAR 625 VOLT 4800
Hz 60 PH 3 CONN. DELTA
CONN. DIAG.

READ INST. GEH-2711

NP220452

NOTE:
ADD "037" SUFFIX TO
CATALOG NO. FOR
CSA LABELED PRODUCT.

	CAPACITOR & POWER PROTECTION FORT EDWARD, N.Y., U.S.A.	
	DRAWN JCozzens	JULY 30, 1997
ISSUED	SCALE	

SIZE A	APPROX. WT 265 LBS
SCALE	

OUTLINE 37F0528422	SHEET 2
DISTR TO	