

101N140  
LOCATE ON  
CENTER OF  
COVER

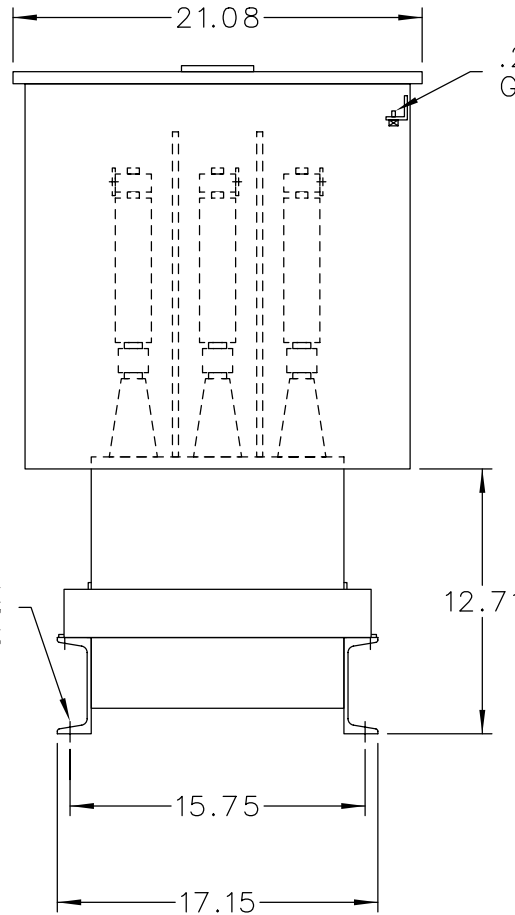

.25-20  
GRD SCR.

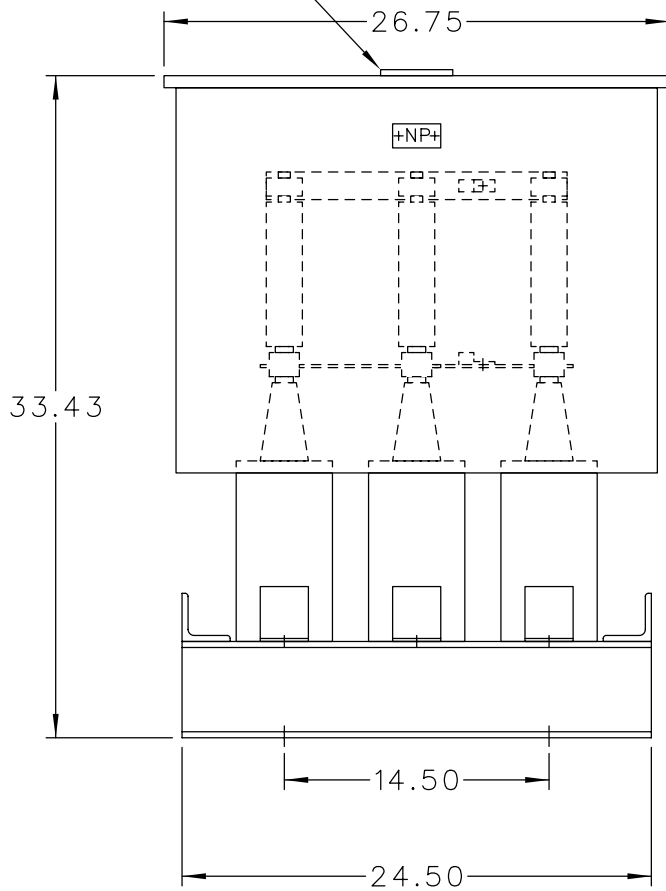
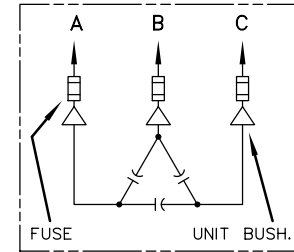

SCHEMATIC DIAGRAM

INCLUDES DISCHARGE RESISTORS

CAT. 37F0528440 SER.NO.  
KVAR 525 VOLT 4800  
Hz 60 PH 3 CONN. DELTA  
CONN. DIAG.

READ INST. GEH-2711

NP220452

NOTE:  
ADD "037" SUFFIX TO  
CATALOG NO. FOR  
CSA LABELED PRODUCT.

	CAPACITOR & POWER PROTECTION FORT EDWARD, N.Y., U.S.A.	
	DRAWN E.McGINN	MAY 18, 1994
ISSUED	SCALE	

SIZE <b>A</b>	APPROX.WT 236 LBS
SCALE	

OUTLINE <b>37F0528440</b>	SHEET 2
DISTR TO	