

101N140
LOCATE ON
CENTER OF
COVER

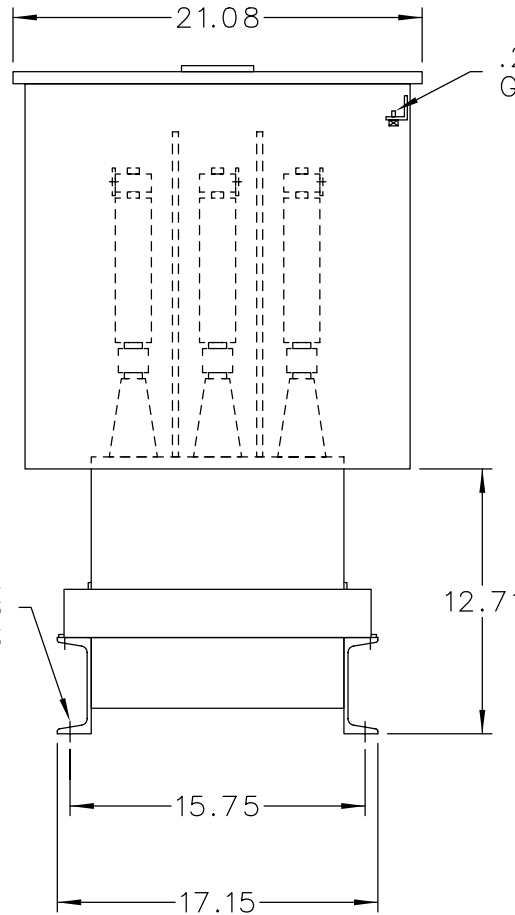

.25-20
GRD SCR.

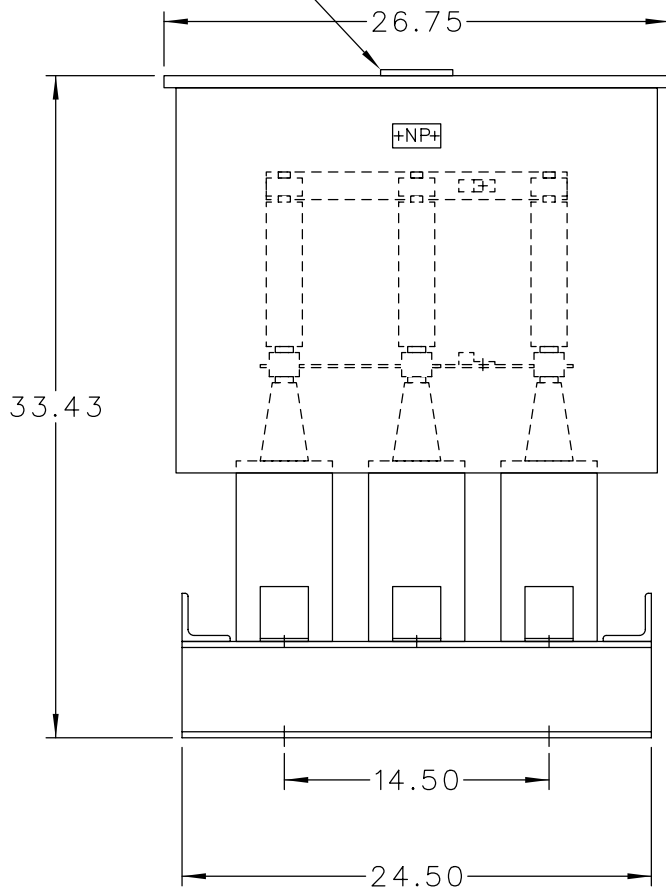
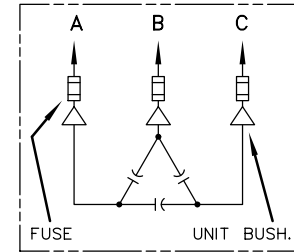

SCHEMATIC DIAGRAM

INCLUDES DISCHARGE RESISTORS

CAT. 37F0528441 SER.NO.
KVAR 575 VOLT 4800
Hz 60 PH 3 CONN. DELTA
CONN. DIAG.

READ INST. GEH-2711

NP220452

NOTE:
ADD "037" SUFFIX TO
CATALOG NO. FOR
CSA LABELED PRODUCT.

 <p>CAPACITOR & POWER PROTECTION FORT EDWARD, N.Y., U.S.A.</p>	<p>DRAWN E.McGINN</p>	<p>MAY 18, 1994</p>
	<p>ISSUED</p>	

<p>SIZE A</p>	<p>APPROX.WT 248 LBS</p>
<p>SCALE</p>	

<p>OUTLINE 37F0528441</p>
<p>SHEET 2</p>

DISTR TO