

CONNECTION  
FOR USER  
SUPPLIED  
120V POWER

BLOWN FUSE  
INDICATING  
LIGHTS

TERMINAL FOR  
#6 TO 250  
MCM CABLE

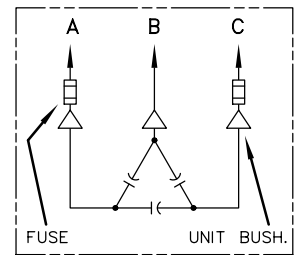
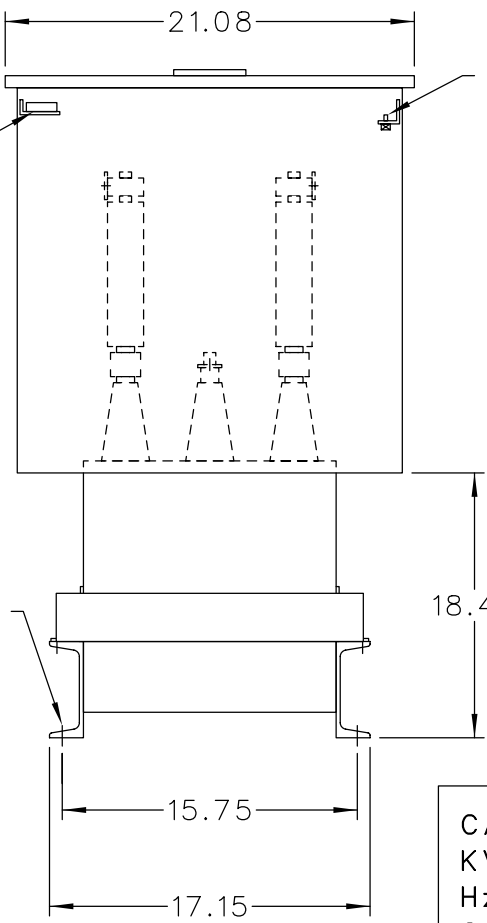

SCHEMATIC DIAGRAM

INCLUDES DISCHARGE RESISTORS

CAT. 37F0528527 SER. NO.  
KVAR 750 VOLT 4800  
Hz 60 PH 3 CONN. DELTA  
CONN. DIAG.

READ INST. GEH-2711

NP220452

NOTE:  
ADD "037" SUFFIX TO  
CATALOG NO. FOR  
CSA LABELED PRODUCT.

	CAPACITOR & POWER PROTECTION FORT EDWARD, N.Y., U.S.A.	
	DRAWN E. McGINN	OCT. 23, 1998
ISSUED	SCALE	

SIZE <b>A</b>	APPROX. WT 298 LBS
SCALE	

OUTLINE <b>37F0528527</b>	SHEET 2
DISTR TO	