

SIZE A	DWG NO 65L560TA1	SHT 1	REV 1
REV 1	DESCRIPTION DEL PIPE CONN	DATE	APPROVED EJM

TOL	+/-
A	.06
B	.12
C	.18
D	.25
E	.02

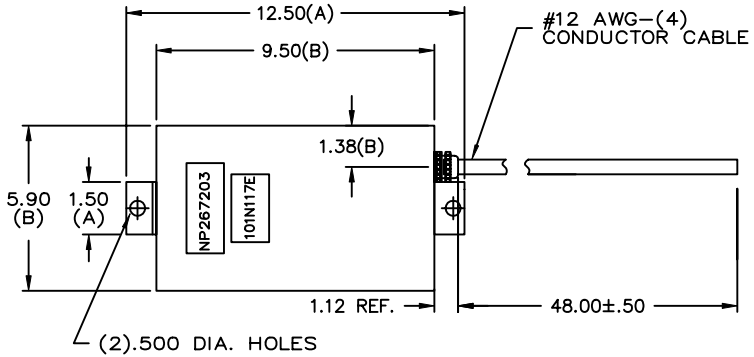

- 1 - RED LEAD
- 2 - BLACK LEAD
- 3 - WHITE LEAD
- GRD. - GREEN LEAD

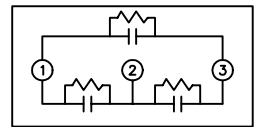

SCHEMATIC DIAGRAM - 302

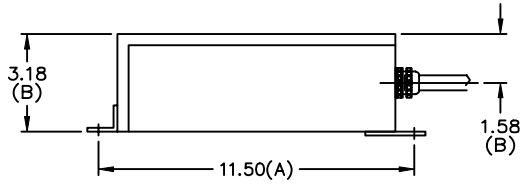

CAT. 65L560TA1 SN
 480V 60Hz 12.5 KVAR
 3PH BIL KV
 0.05 GAL COMBUSTIBLE LIQUID
 CAUTION! BEFORE INSTALLING
 OR OPERATING READ GEH-2729
 NP267203

INDUSTRIAL SYSTEMS FORT EDWARD, N.Y., U.S.A.		SIZE A
DRAWN E. McGinn	DATE 8/09/91	SCALE
ISSUED	DATE 8/12/91	

OUTLINE
 65L560TA1

SHEET 2	CONT -
------------	-----------

EJSTR-TU