

SIZE <b>A</b>	DWG NO. 65L800TK1	SH 2	REV
NEW	01/10/91		DATE
1	ADD NP 101N140	10/20/93	

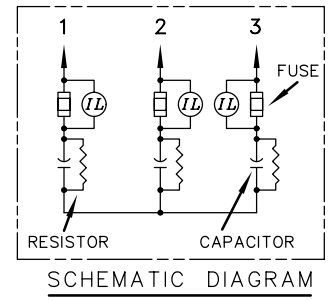
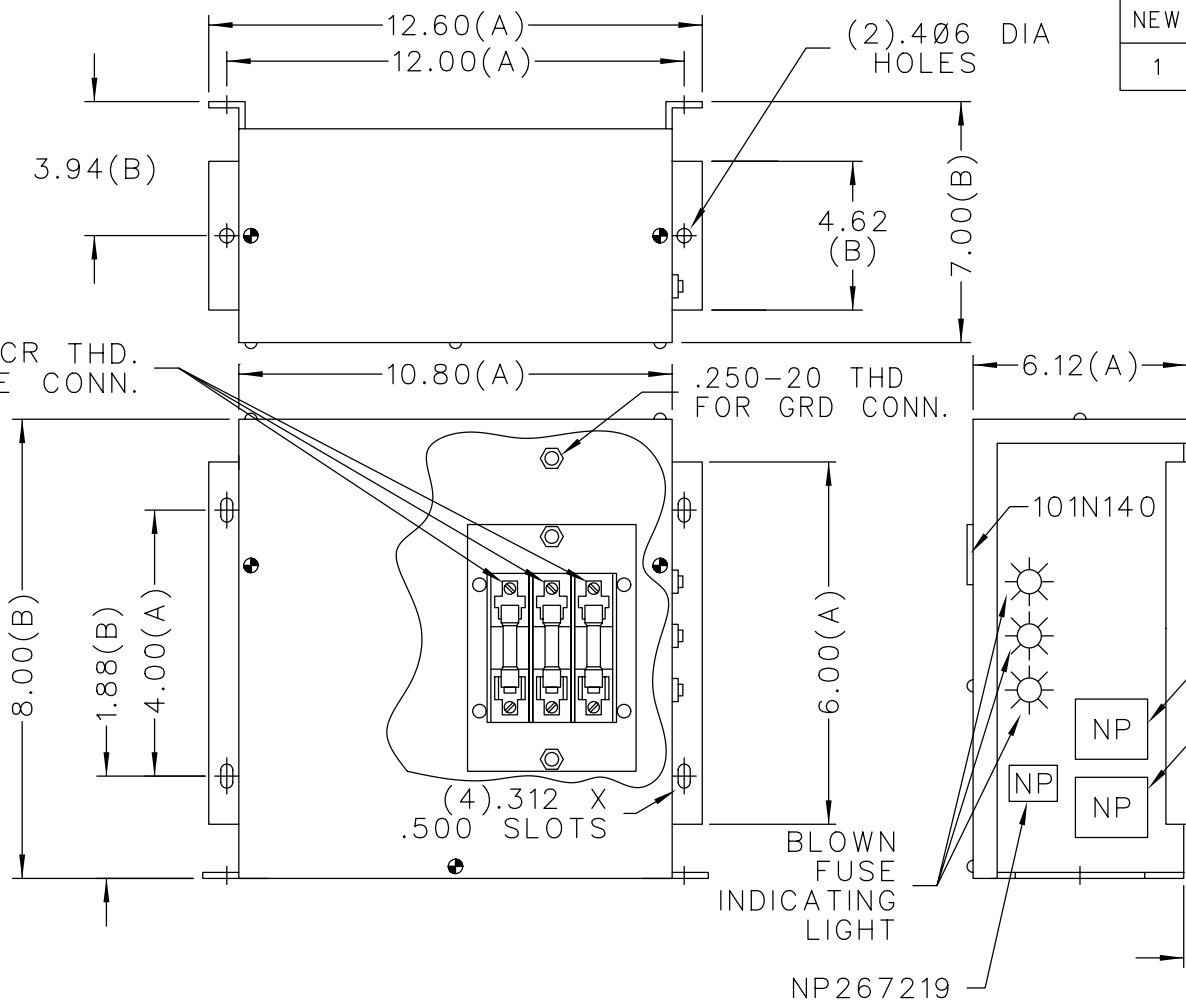

TOL	+/-
A	.06
B	.12
C	.18
D	.25

CAT 65L800TK1 SN  
 1 KVAR 600V 60HZ 3PH  
 0.06 GAL  
 MFG DATE  
 READ GEH-2738  
 NP267203

 CAPACITOR & POWER PROTECTION OPERATION LOCATION: FORT EDWARD, N.Y., U.S.A.	SIZE <b>A</b>	EST. WT. 9 Lbs.	<b>OUTLINE</b> <b>65L800TK1</b>	DISTR TO
	DRAWN 01/02/91 ISSUED 01/10/91	SCALE		