

SIZE <b>A</b>	DWG NO. 65L800TL1	SH 2	REV
NEW	01/24/91		
1	ADD NP 101N140	DATE 10/20/93	

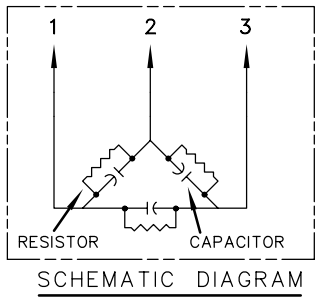
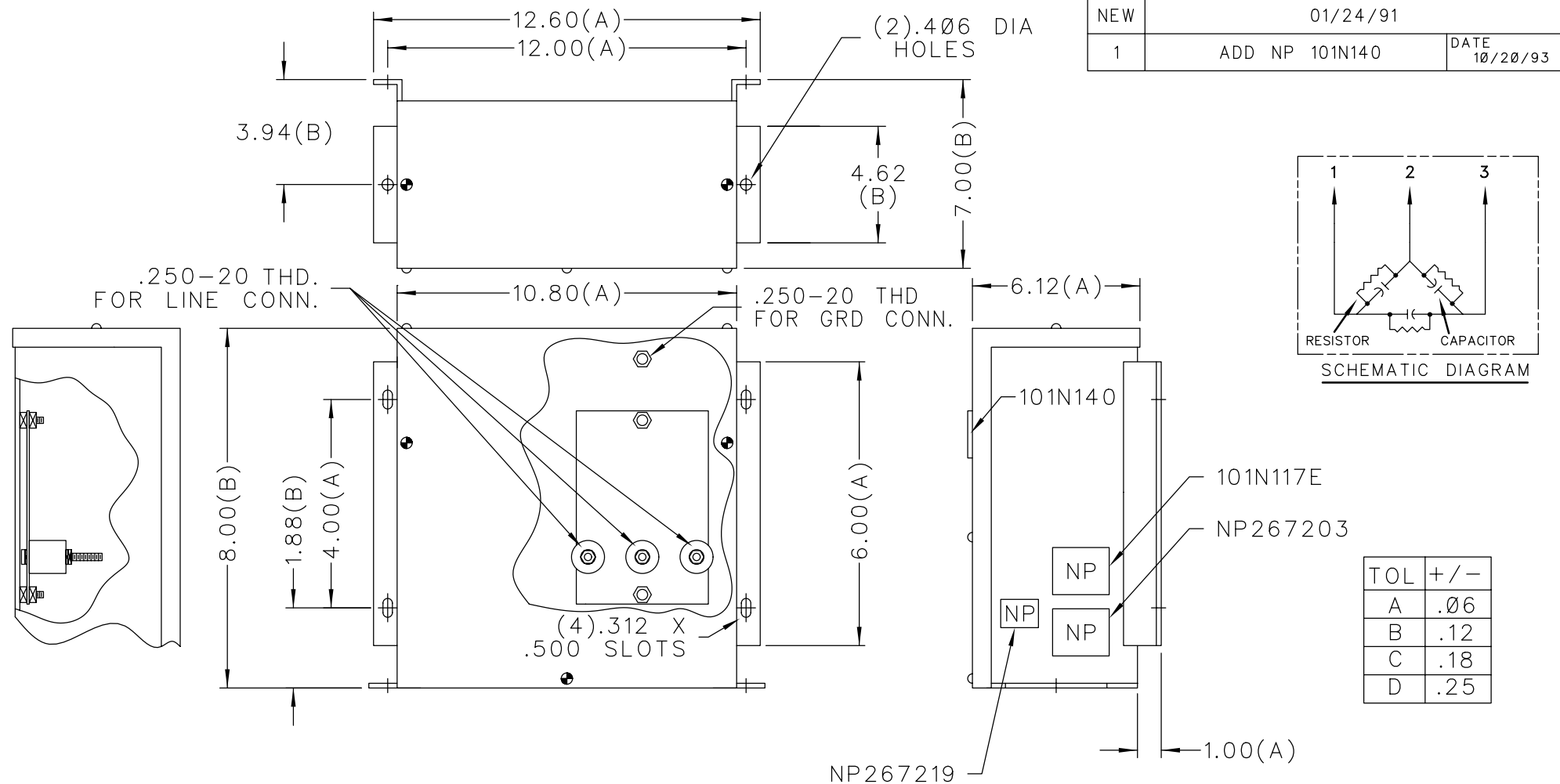

TOL	+/-
A	.06
B	.12
C	.18
D	.25

CAT 65L800TL1 SN  
 1 KVAR 240V 60HZ 3PH  
 0.06 GAL  
 MFG DATE  
 READ GEH-2738  
 NP267203

 CAPACITOR & POWER PROTECTION OPERATION LOCATION: FORT EDWARD, N.Y., U.S.A.	SIZE <b>A</b>	EST. WT. 9 Lbs.	<b>OUTLINE</b> <b>65L800TL1</b>	DISTR TO
	DRAWN 01/02/91 ISSUED 01/24/91	SCALE		