

SIZE A	DWG NO. 65L801TS1	SH 2	REV
NEW	01/31/91		
1	ADD NP 101N140	DATE 10/20/93	

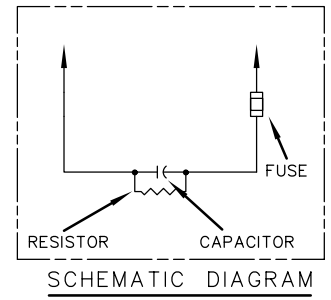
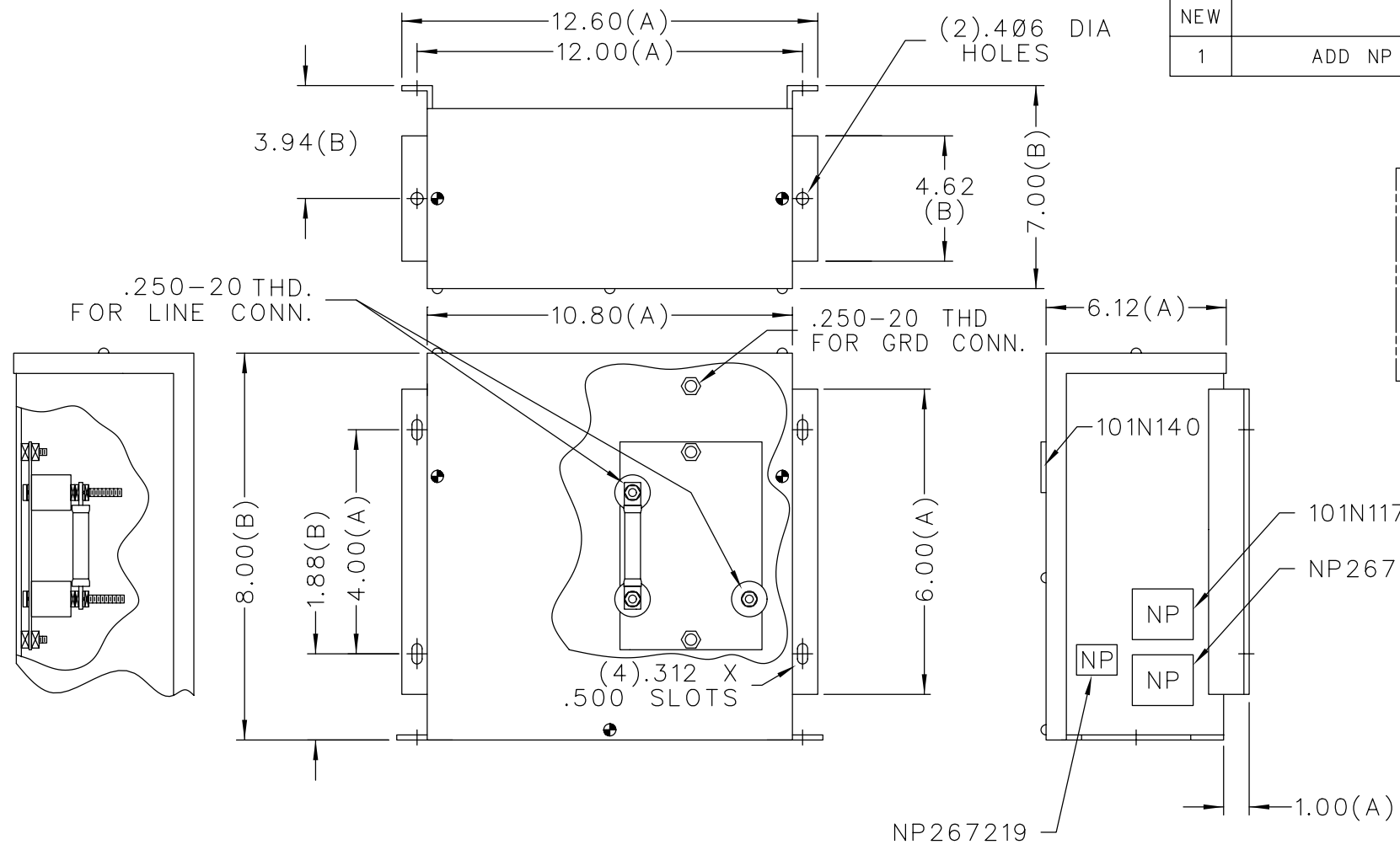

TOL	+/-
A	.06
B	.12
C	.18
D	.25

CAT 65L801TS1 SN
 1.5 KVAR 480V 60HZ 1PH
 0.06 GAL
 MFG DATE
 READ GEH-2738
 NP267203

 CAPACITOR & POWER PROTECTION OPERATION LOCATION: FORT EDWARD, N.Y., U.S.A.	SIZE A	EST. WT. 9 Lbs.	OUTLINE 65L801TS1	DISTR TO
	DRAWN 01/02/91 ISSUED 01/31/91	SCALE		