

SIZE A	DWG NO. 65L805TY1	SH 2	REV
NEW	02/07/91		
1	ADD NP 101N140	DATE 10/20/93	

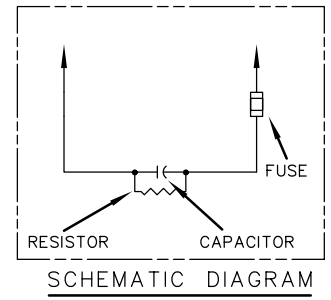
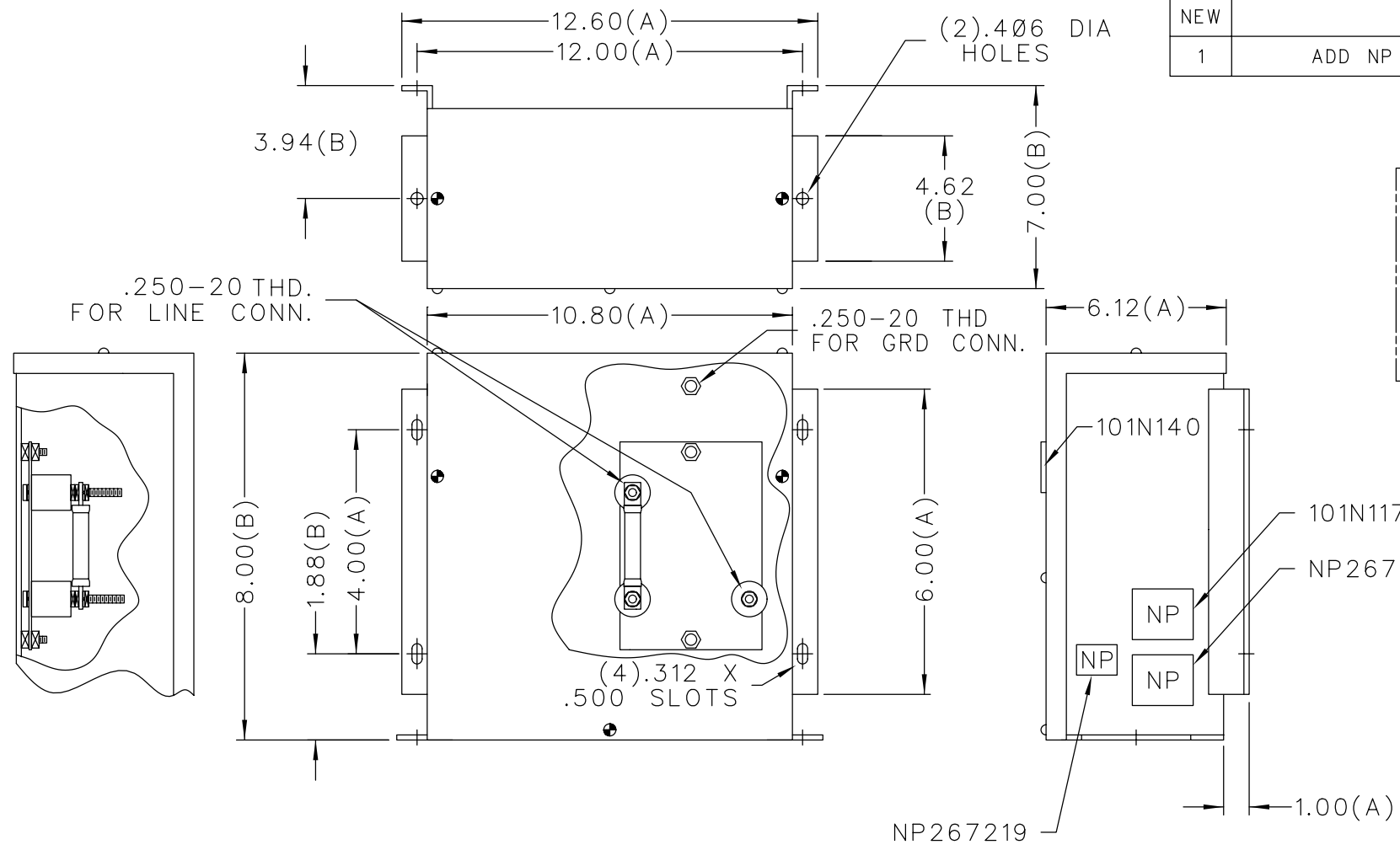

TOL	+/-
A	.06
B	.12
C	.18
D	.25

CAT 65L805TY1 SN
 4 KVAR 240V 60HZ 1PH
 0.09 GAL
 MFG DATE
 READ GEH-2738
 NP267203

 CAPACITOR & POWER PROTECTION OPERATION LOCATION: FORT EDWARD, N.Y., U.S.A.	SIZE A	EST. WT. 10 Lbs.	OUTLINE 65L805TY1	DISTR TO
	DRAWN 01/02/91 ISSUED 02/07/91	SCALE		