

SIZE A	DWG NO. 65L807TZ1	SH 2	REV
NEW	02/07/91		
1	ADD NP 101N140	DATE 10/20/93	

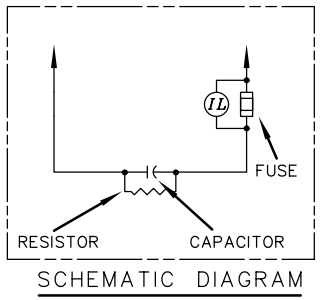
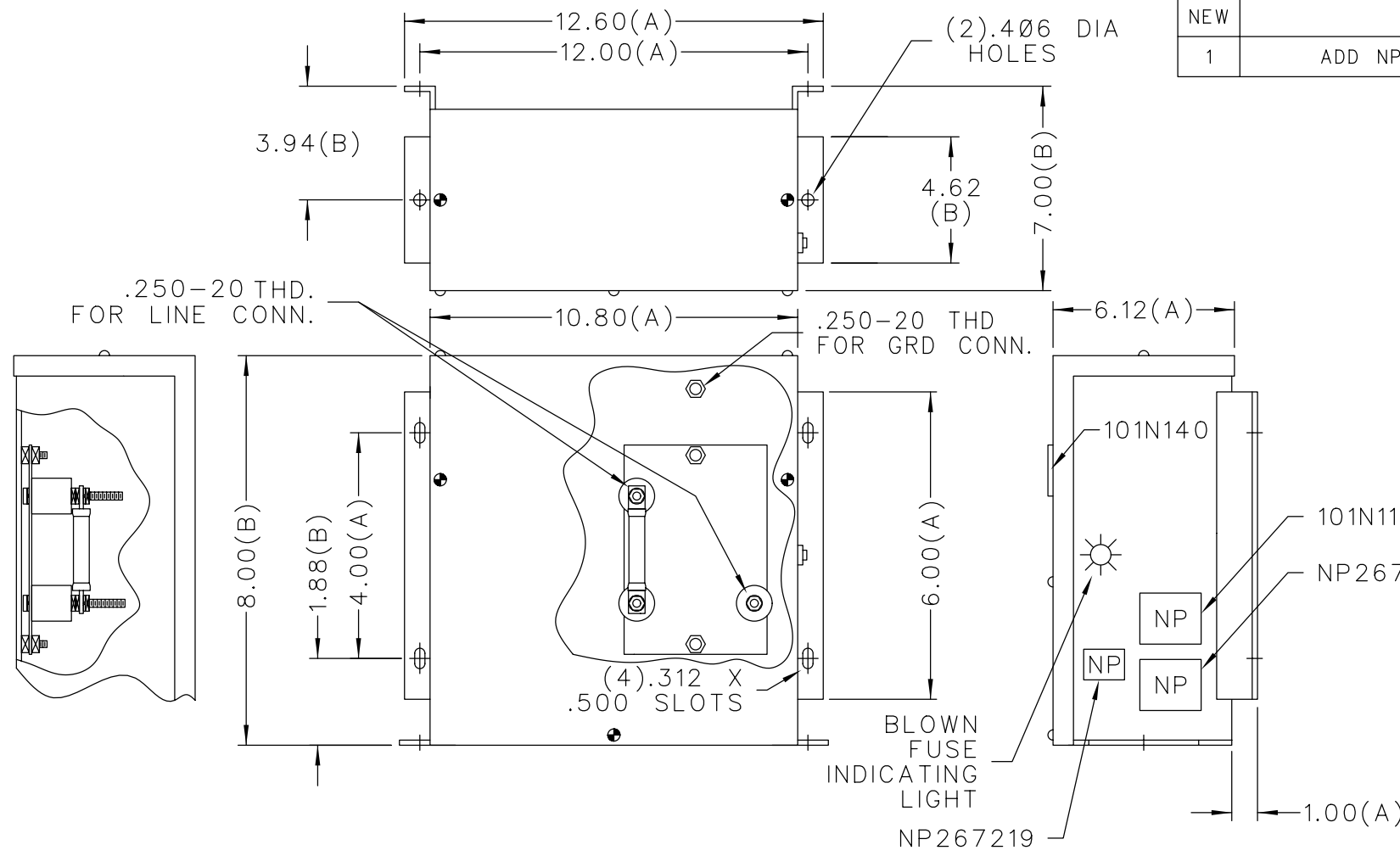

TOL	+/-
A	.06
B	.12
C	.18
D	.25

CAT 65L807TZ1 SN
6 KVAR 240V 60HZ 1PH

0.09 GAL

MFG DATE
READ GEH-2738

NP267203

 CAPACITOR & POWER PROTECTION OPERATION LOCATION: FORT EDWARD, N.Y., U.S.A.	SIZE A	EST. WT. 11 Lbs.	OUTLINE 65L807TZ1	DISTR TO
	DRAWN 01/02/91 ISSUED 02/07/91	SCALE		