

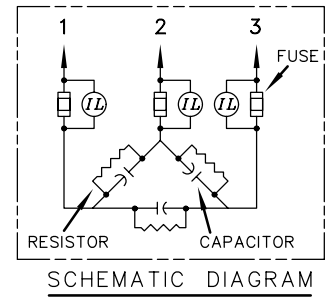

SIZE A	DWG NO. 65L817TE1	SH 2	REV
NEW	01/14/91		
1	ADD NP 101N140	DATE 10/20/93	

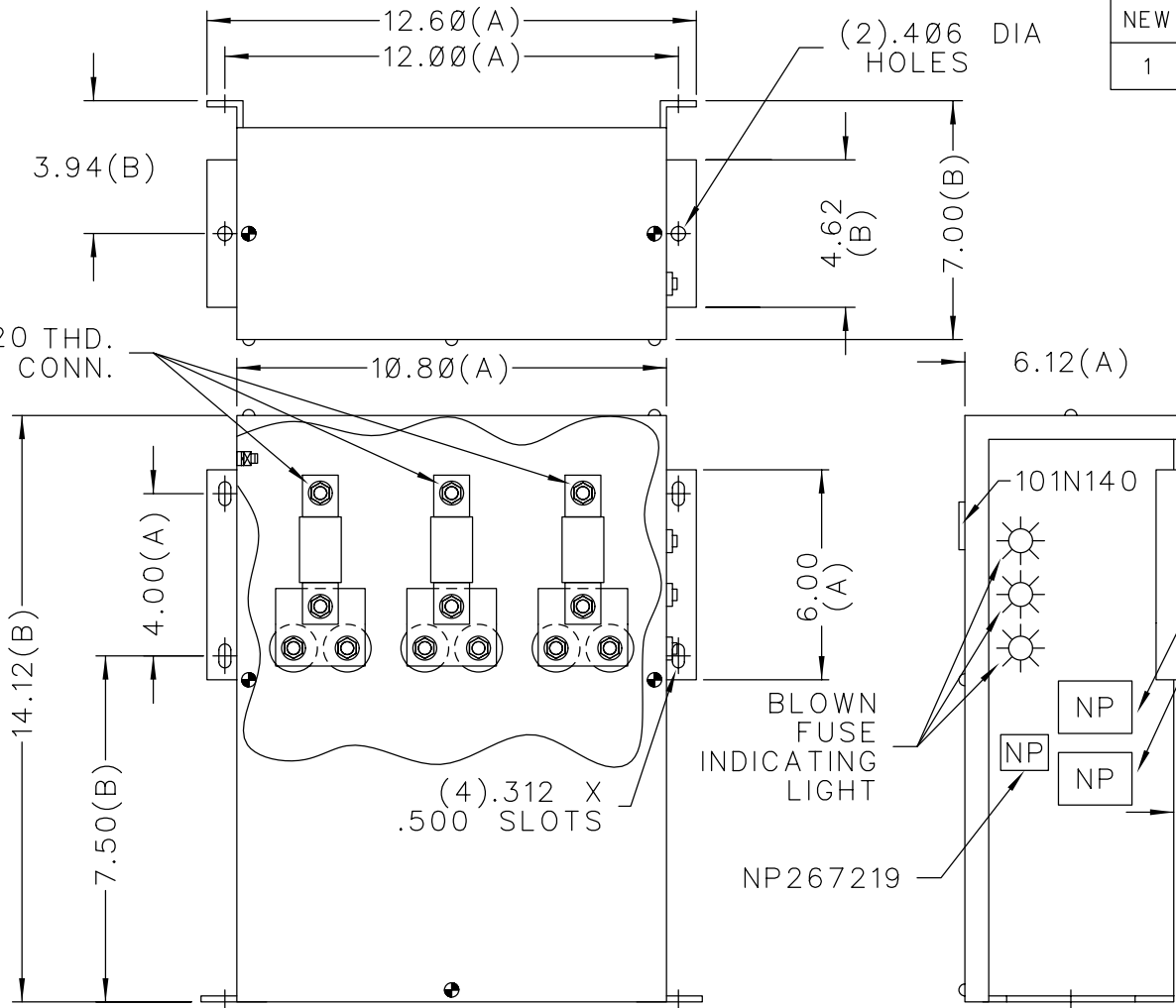

TOL	+/-
A	.06
B	.12
C	.18
D	.25

CAT 65L817TE1 SN
 30 KVAR 480V 60HZ 3PH
 0.24 GAL
 MFG DATE
 READ GEH-2738

NP267203

 CAPACITOR & POWER PROTECTION
 FORT EDWARD, N.Y., U.S.A.

DRAWN 01/02/91
 ISSUED 01/14/91

SIZE
A

EST. WT.
19 Lbs.

SCALE

OUTLINE
65L817TE1

SHEET 2

DISTR TO