

SIZE A	DWG NO. 65L822TT1	SH 2	REV
NEW	01/31/91		
1	ADD NP 101N140	DATE 10/20/93	

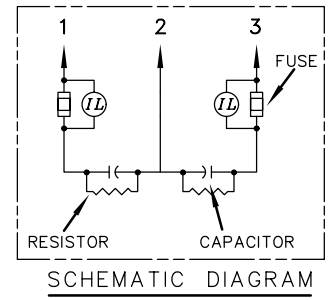
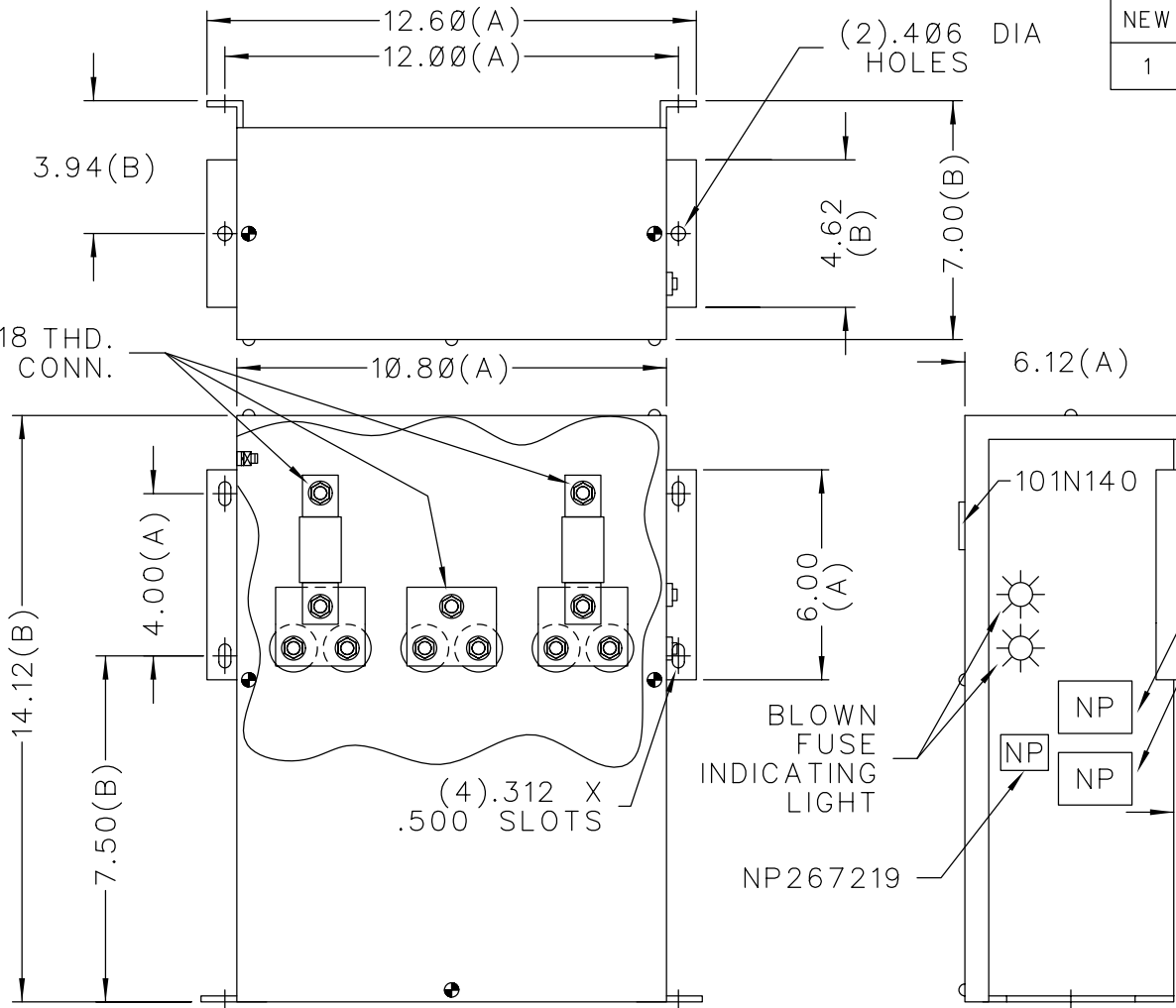

TOL	+/-
A	.06
B	.12
C	.18
D	.25

CAT 65L822TT1 SN
 42.5 KVAR 480V 60HZ 1PH
 0.29 GAL
 MFG DATE
 READ GEH-2738

NP267203

 CAPACITOR & POWER PROTECTION FORT EDWARD, N.Y., U.S.A.	SIZE A	EST. WT. 21 Lbs.	OUTLINE 65L822TT1	DISTR TO
	DRAWN 01/02/91 ISSUED 01/31/91	SCALE		