

SIZE <b>A</b>	DWG NO. 65L825TR1	SH 2	REV
NEW	01/31/91		
1	ADD NP 101N140	DATE 10/20/93	

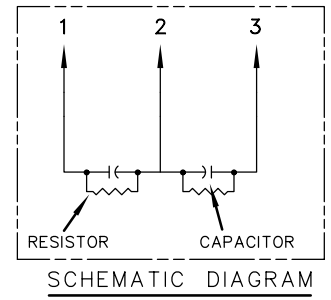
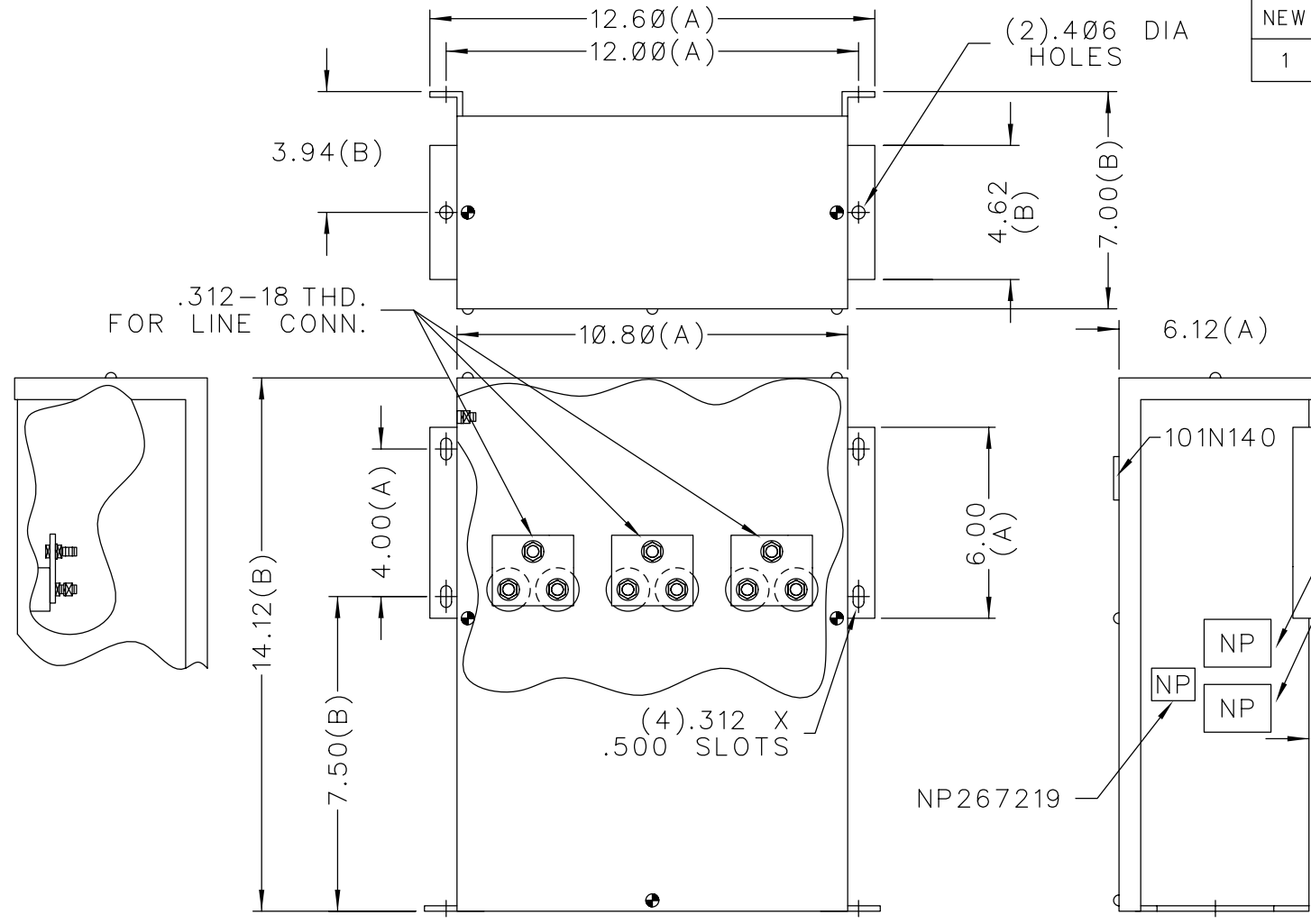

TOL	+/-
A	.06
B	.12
C	.18
D	.25

CAT 65L825TR1 SN  
 50 KVAR 480V 60HZ 1PH  
 0.21 GAL  
 MFG DATE  
 READ GEH-2738  
 NP267203

 CAPACITOR & POWER PROTECTION FORT EDWARD, N.Y., U.S.A.	SIZE <b>A</b>	EST. WT. 21 Lbs.	<b>OUTLINE</b> <b>65L825TR1</b>	DISTR TO
	DRAWN 01/02/91 ISSUED 01/31/91	SCALE		