

SIZE A	DWG NO 65L906TL3	SHT 2	REV
REV	DESCRIPTION	DATE	APPROVED

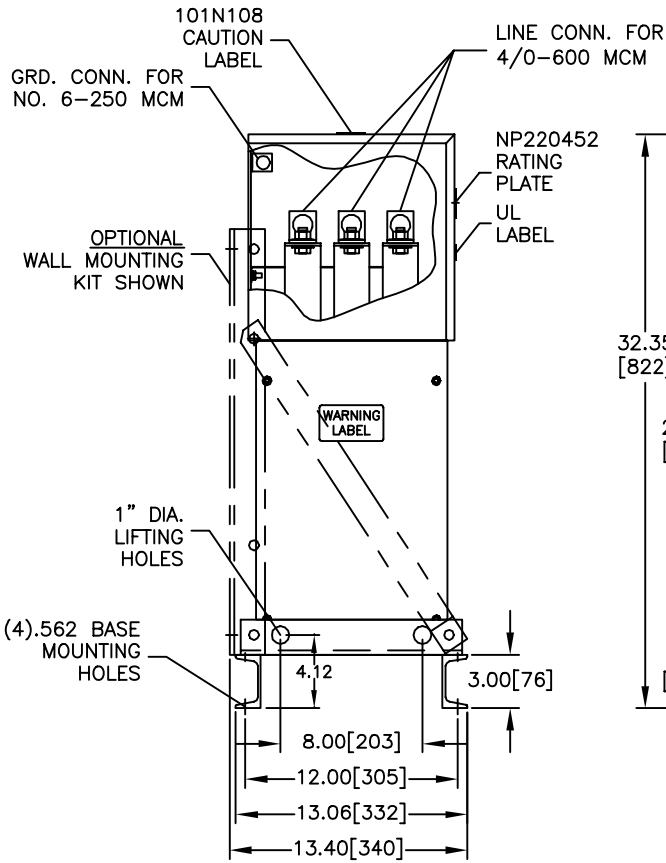

FRONT VIEW
SHOWN WITH TOP/FRONT COVER REMOVED

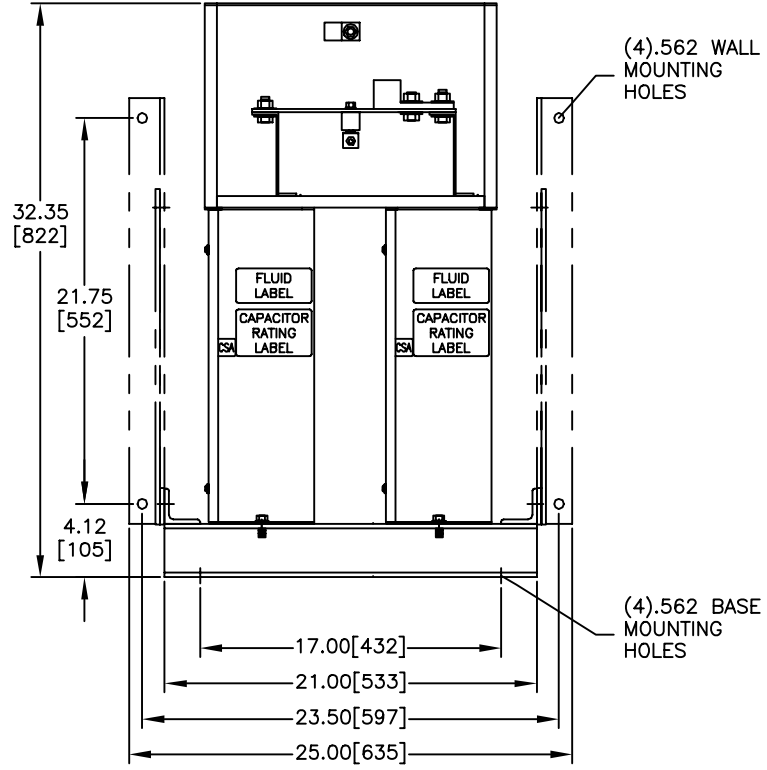

CAPACITOR

CAT. 65L906TL3 SER.NO.

kVAR 65 60 Hz 3 Ph

VOLT. 240 CONN. DELTA

DIAG. 186C3233EM

CAUTION BEFORE INSTALLING OR OPERATING READ INST. 2738

CAPACITOR UNITS CONTAIN CLASS III B COMBUSTIBLE LIQUID.
CAPACITOR UNITS INCLUDE INTERNAL DISCHARGE RESISTORS.
NP220452 FORT EDWARD, N.Y. MADE IN U.S.A.

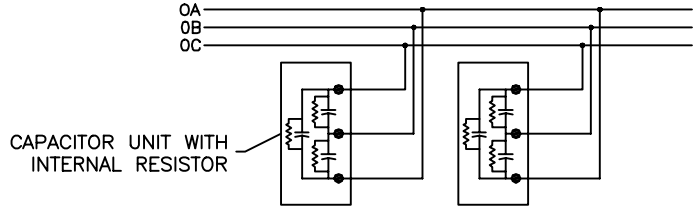

CONNECTION DIAGRAM

INDUSTRIAL SYSTEMS FORT EDWARD, N.Y., U.S.A.	SIZE A	EST. WEIGHT: 89	<h1 style="margin: 0;">OUTLINE</h1> <h1 style="margin: 0;">65L906TL3</h1>
	SCALE	GALLONS LIQUID: 0.73	
DRAWN A.COZZENS	DATE 7/10/2003		
ISSUED	DATE 7/16/2003	SHEET 2	CONT ON —

DISTR. TO