

REVISIONS			
REV	DESCRIPTION	DATE	APPROVED
1	UPDATE TO AUTOCAD		KS

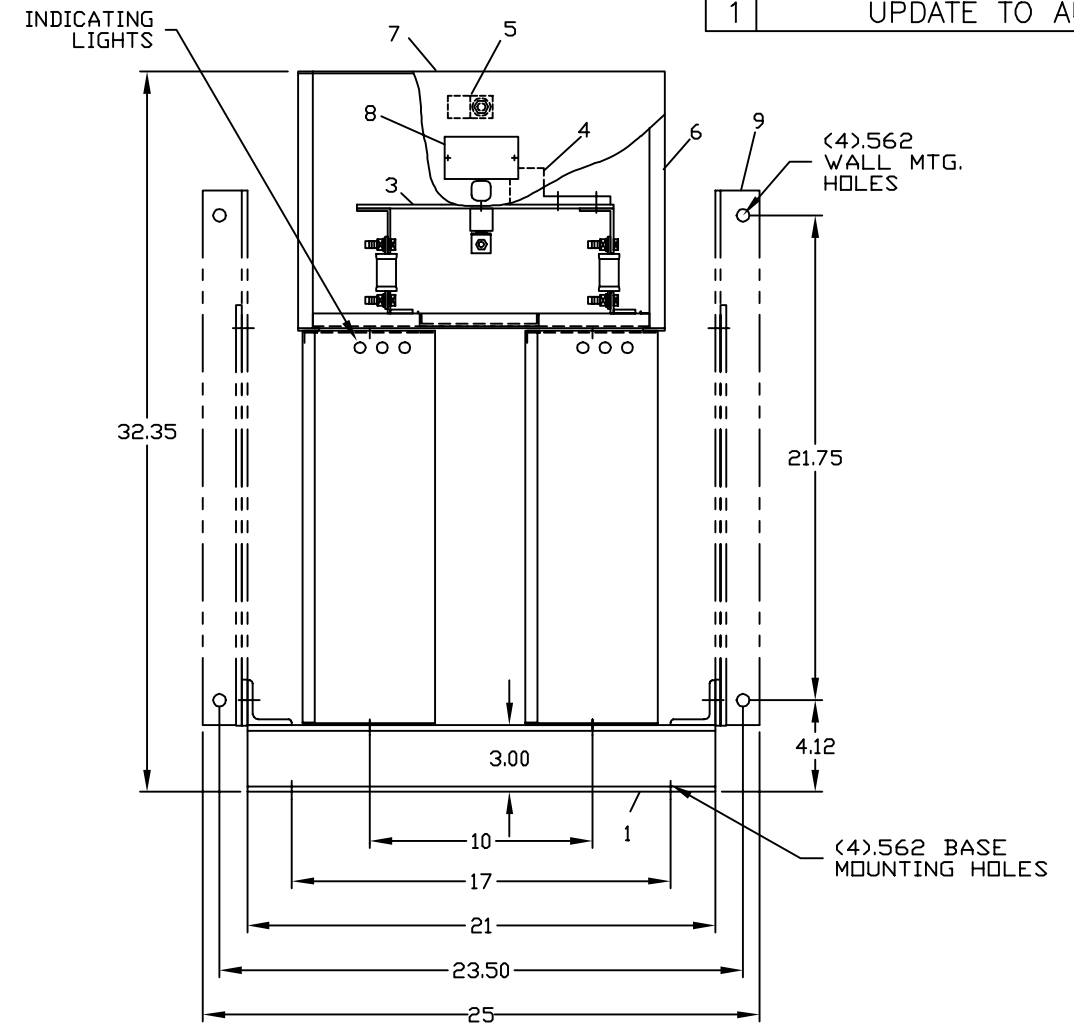

- NOMENCLATURE**
1. ALUMINUM BASE FRAME
 2. CAPACITOR UNIT
 3. COPPER BUS BARS
 4. LINE TERMINAL - #4/0 TO 600 MCM
 5. GROUND TERMINAL - #6AWG TO 250 MCM
 6. BUS ENCLOSURE
 7. ACCESS COVER
 8. RATING NAMEPLATE
 9. OPTIONAL FIELD ASSEMBLED WALL MTG. FRAME

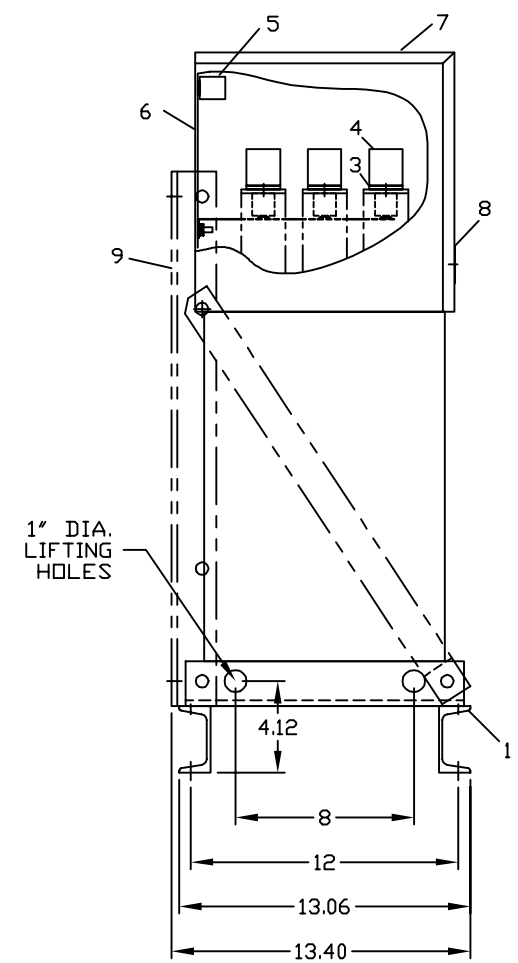
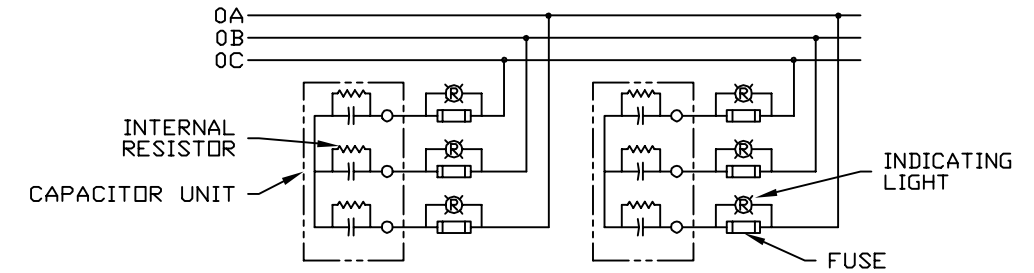

CONNECTION DIAGRAM

SIGNATURES		DATE		INDUSTRIAL SYSTEMS FORT EDWARD, N.Y., U.S.A.	
DRAWN E.McGINN		9/18/92			
CHECKED					
ENGR					
ISSUED		9/30/93		OUTLINE 65L911TK2	
CAD SYS. NO.		SIZE C	FSCM NO.	DWG NO. 65L911TK2	REV 1
AUTOCAD		SCALE	SHEET	CONT ON SHT	DISTR TO

CAT 65L911TK2 SERNO
 KVAR 90 60Hz 3ph
 VOLT 600 DIAG 186C3233EA
 CONN Y-CONN

Read instructions: GEH-2728