

REVISIONS			
REV	DESCRIPTION	DATE	APPROVED
1	UPDATE TO AUTOCAD		EJM

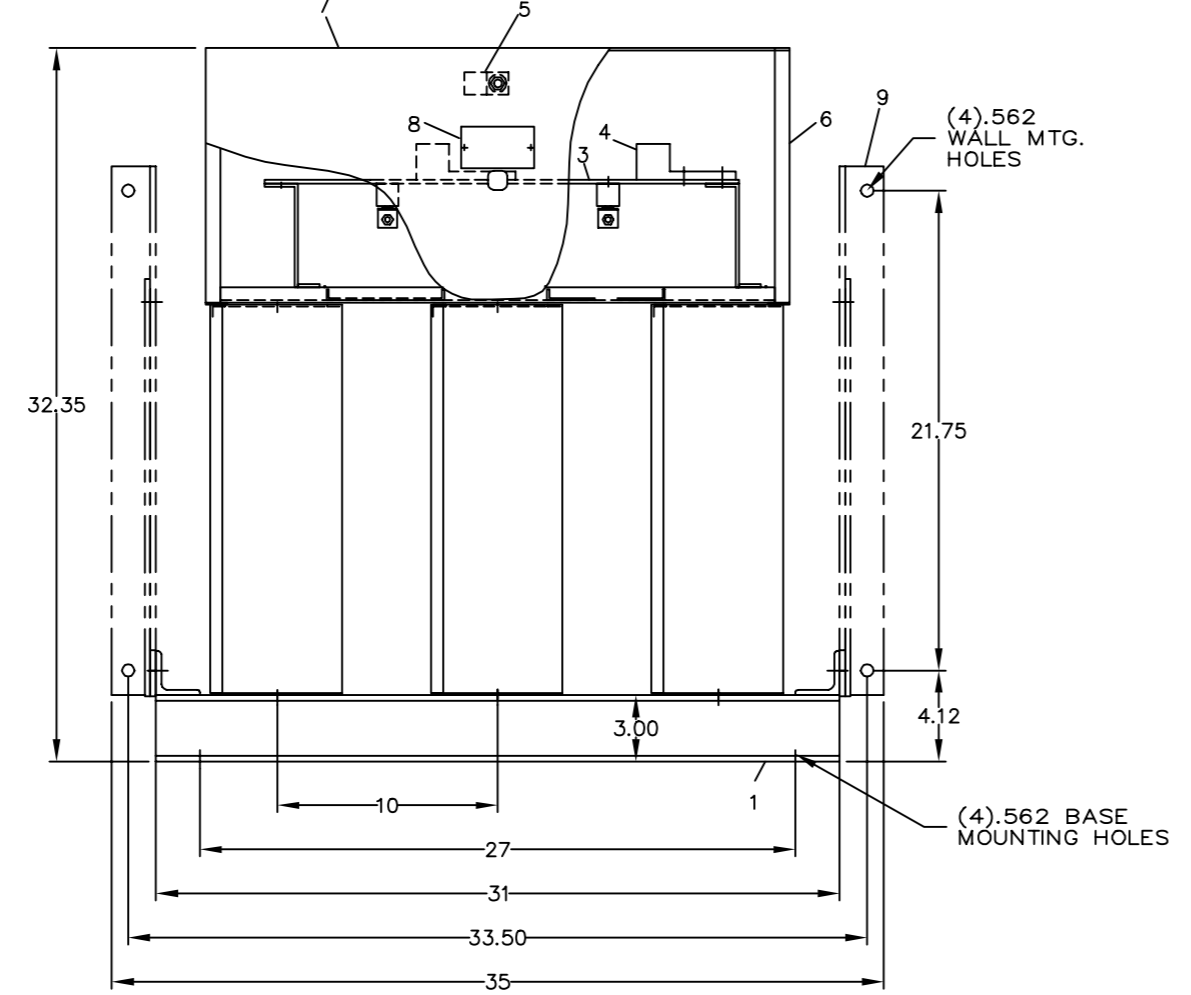

- NOMENCLATURE**
1. ALUMINUM BASE FRAME
 2. CAPACITOR UNIT
 3. COPPER BUS BARS
 4. LINE TERMINAL - #4/O TO 600 MCM
 5. GROUND TERMINAL - #6AWG TO 250 MCM
 6. BUS ENCLOSURE
 7. ACCESS COVER
 8. RATING NAMEPLATE
 9. OPTIONAL FIELD ASSEMBLED WALL MTG. FRAME

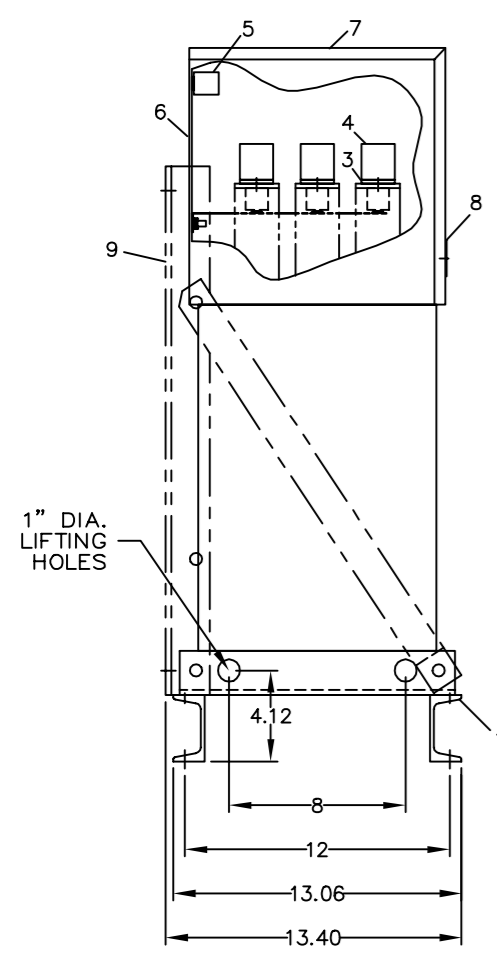
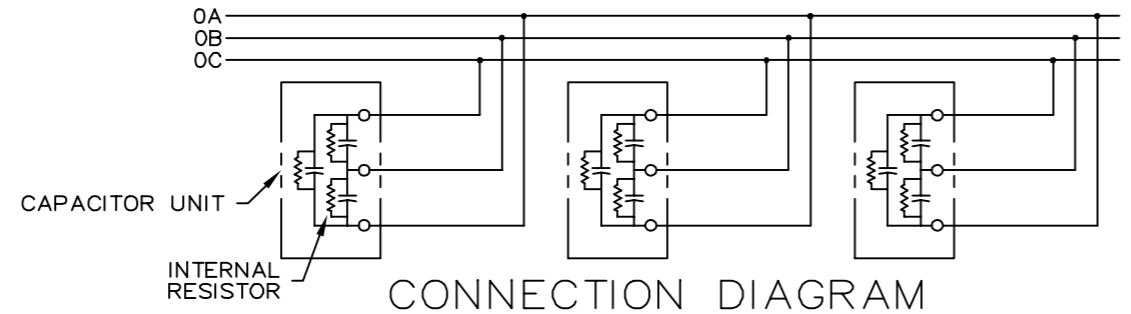

CONNECTION DIAGRAM

SIGNATURES		DATE		INDUSTRIAL SYSTEMS FORT EDWARD, N.Y., U.S.A. OUTLINE 65L912TL2 FIRST MADE FOR:	413
DRAWN E.McGINN		9/29/93			
CHECKED					
ENGR					
ISSUED		9/30/93			
CAD SYS. NO.		SIZE C	FSCM NO.	DWG NO. 65L912TL2	REV 1
AUTOCAD		SCALE	SHEET 1		CONT ON SHT -

CAT 65L912TL2 SERNO
 KVAR 95 60Hz 3ph
 VOLT 240 DIAG 186C3233FM
 CONN DELTA
 Read instructions: GEH-2728