

REVISIONS			
REV	DESCRIPTION	DATE	APPROVED
1	UPDATE TO AUTOCAD		KS

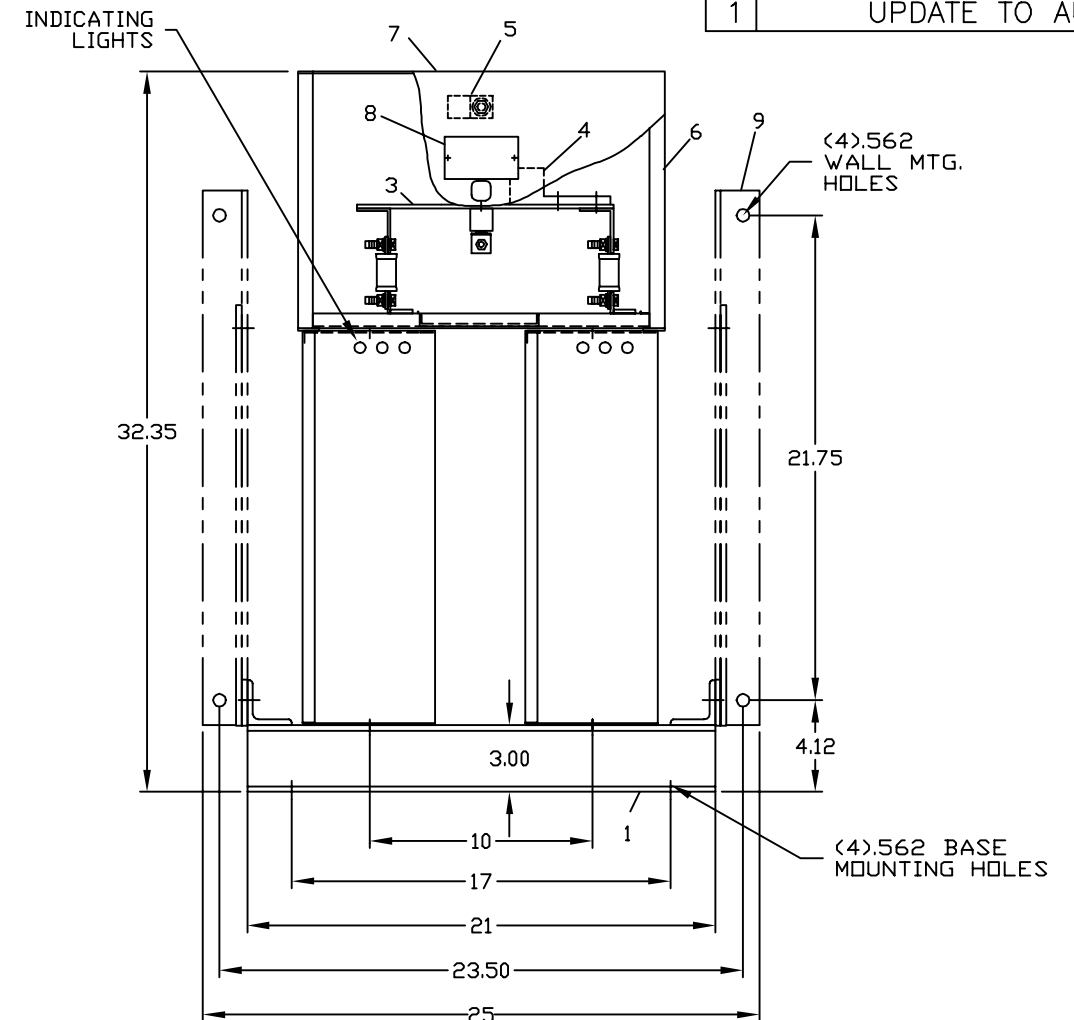

- NOMENCLATURE**
1. ALUMINUM BASE FRAME
 2. CAPACITOR UNIT
 3. COPPER BUS BARS
 4. LINE TERMINAL - #4/0 TO 600 MCM
 5. GROUND TERMINAL - #6AWG TO 250 MCM
 6. BUS ENCLOSURE
 7. ACCESS COVER
 8. RATING NAMEPLATE
 9. OPTIONAL FIELD ASSEMBLED WALL MTG. FRAME

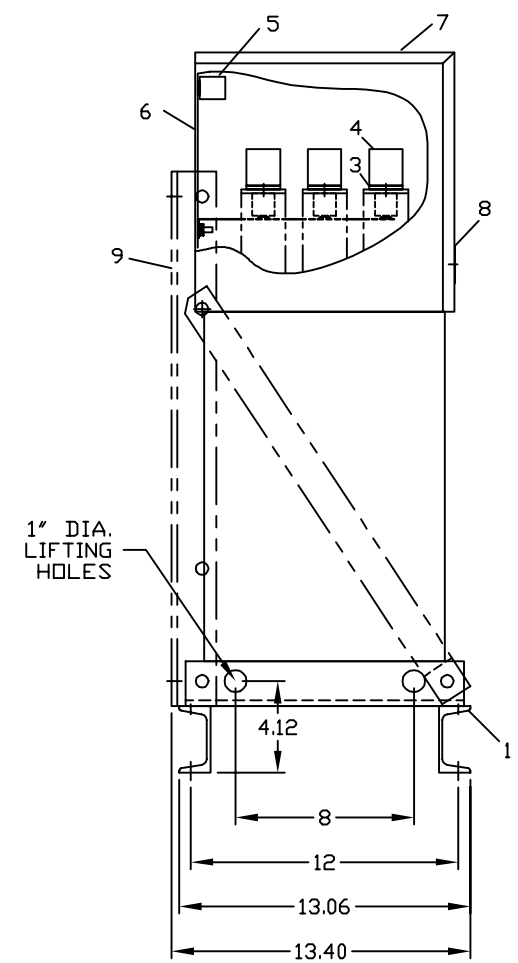
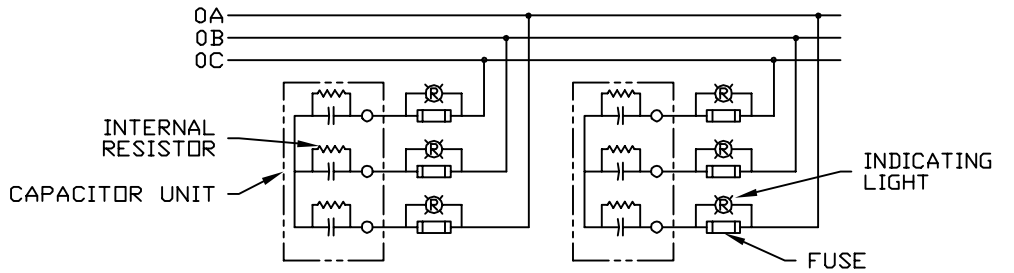

CONNECTION DIAGRAM

SIGNATURES		DATE		INDUSTRIAL SYSTEMS FORT EDWARD, N.Y., U.S.A. OUTLINE 65L915TK2 FIRST MADE FOR:	413 DISTR TO
DRAWN	E.McGINN	9/18/92			
CHECKED					
ENGR					
ISSUED		9/30/93			
CAD SYS. NO.		SIZE	FSCM NO.	DWG NO.	REV
AUTOCAD		C		65L915TK2	1
		SCALE	SHEET		CONT ON SHT

CAT 65L915TK2 SERNO
 KVAR 120 60Hz 3ph
 VOLT 600 DIAG 186C3233EA
 CONN Y-CONN
 Read instructions: GEH-2728