

SIZE	DWG NO.	SHT	REV
C	65L917TL2	1	1

REVISIONS			
REV	DESCRIPTION	DATE	APPROVED
1	UPDATE TO AUTOCAD		FWL

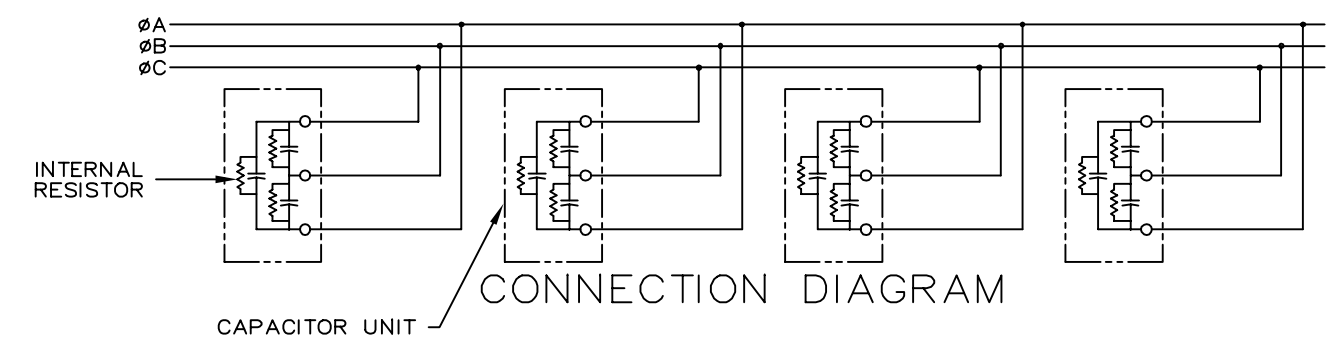
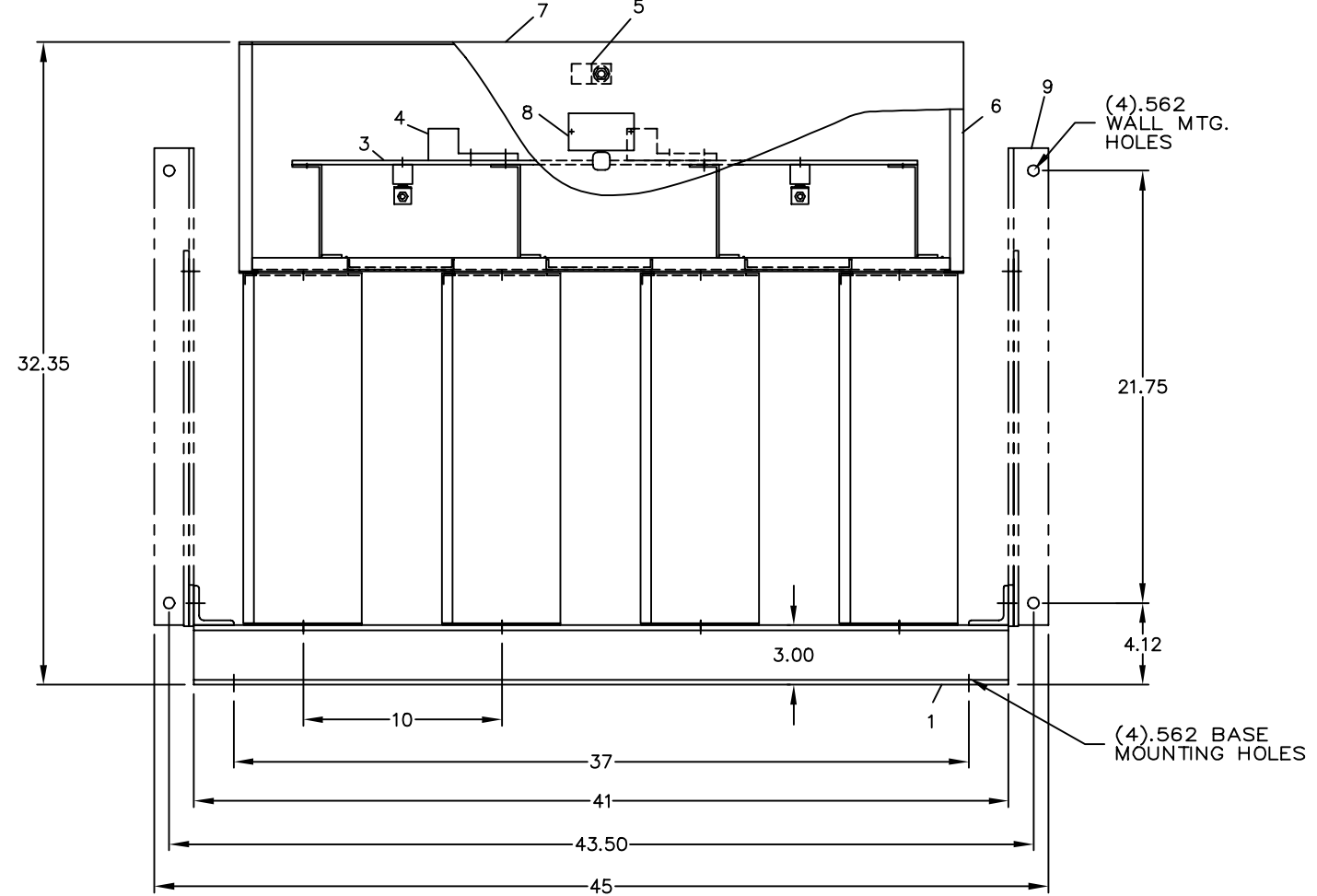
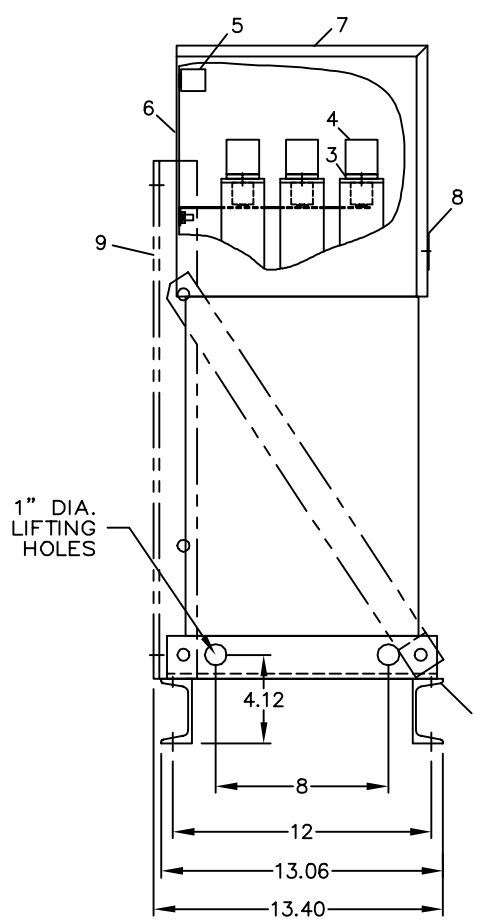

- NOMENCLATURE**
1. ALUMINUM BASE FRAME
 2. CAPACITOR UNIT
 3. COPPER BUS BARS
 4. LINE TERMINAL - #4/0 TO 600 MCM
 5. GROUND TERMINAL - #6AWG TO 250 MCM
 6. BUS ENCLOSURE
 7. ACCESS COVER
 8. RATING NAMEPLATE
 9. OPTIONAL FIELD ASSEMBLED WALL MTG. FRAME

SIGNATURES		DATE		 INDUSTRIAL SYSTEMS FORT EDWARD, N.Y., U.S.A. OUTLINE 65L917TL2 FIRST MADE FOR:	413
DRAWN	E.McGINN	10/1/92			
CHECKED					
ENGR					
ISSUED		9/30/93			
CAD SYS. NO.		SIZE	FSCM NO.	DWG NO.	REV
AUTOCAD		C		65L917TL2	1
		SCALE	SHEET 1		CONT ON SHT -

CAT 65L917TL2 SERNO
 KVAR 130 60Hz 3ph
 VOLT 240 DIAG 186C3233GM
 CONN DELTA
 Read instructions: GEH-2728