

4

3

2

C

SIZE DWG NO.

65L918TR2

SHT

REV NO.

1

1

REVISIONS			
REV	DESCRIPTION	DATE	APPROVED
1	UPDATE TO AUTOCAD		KS

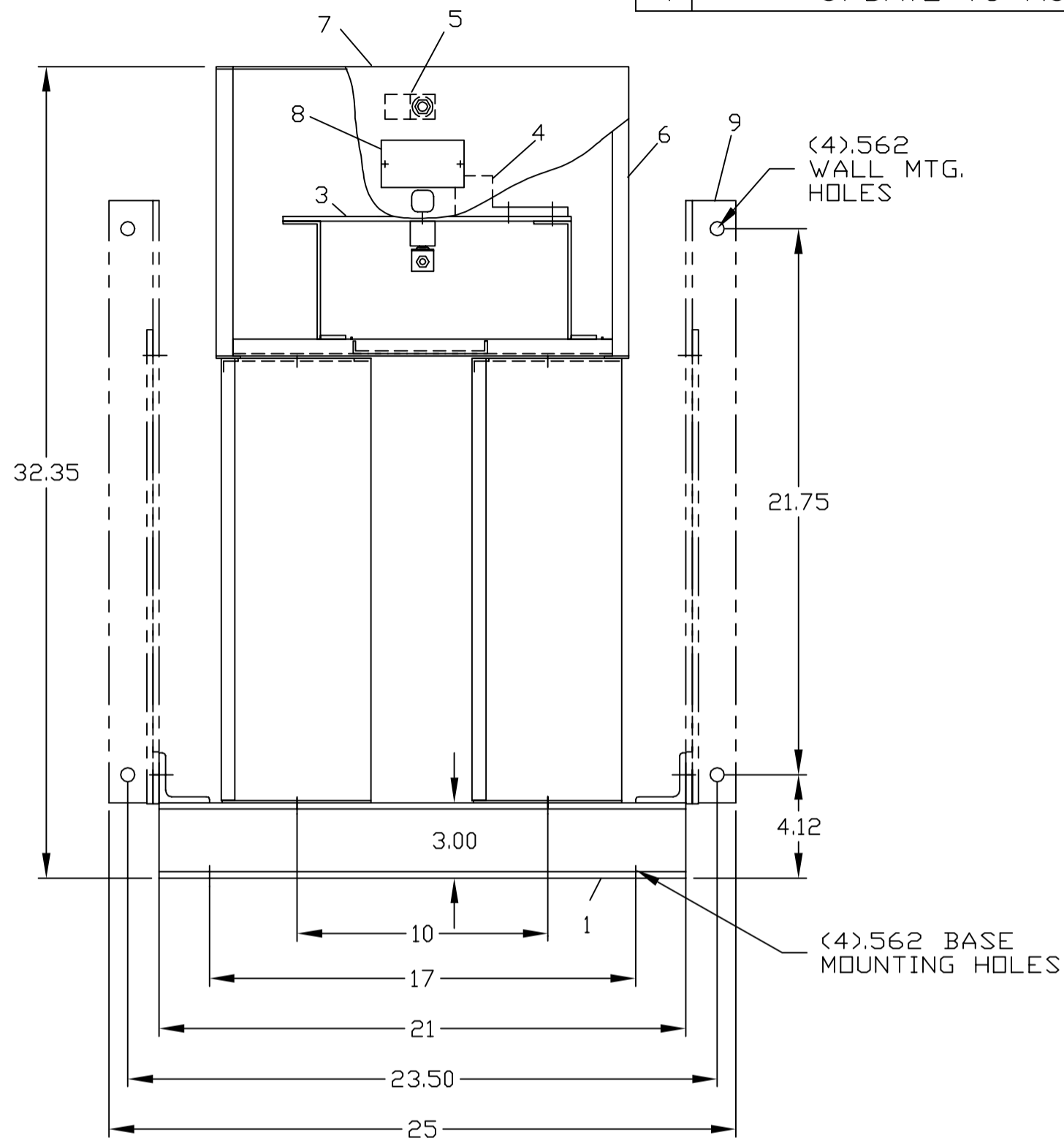
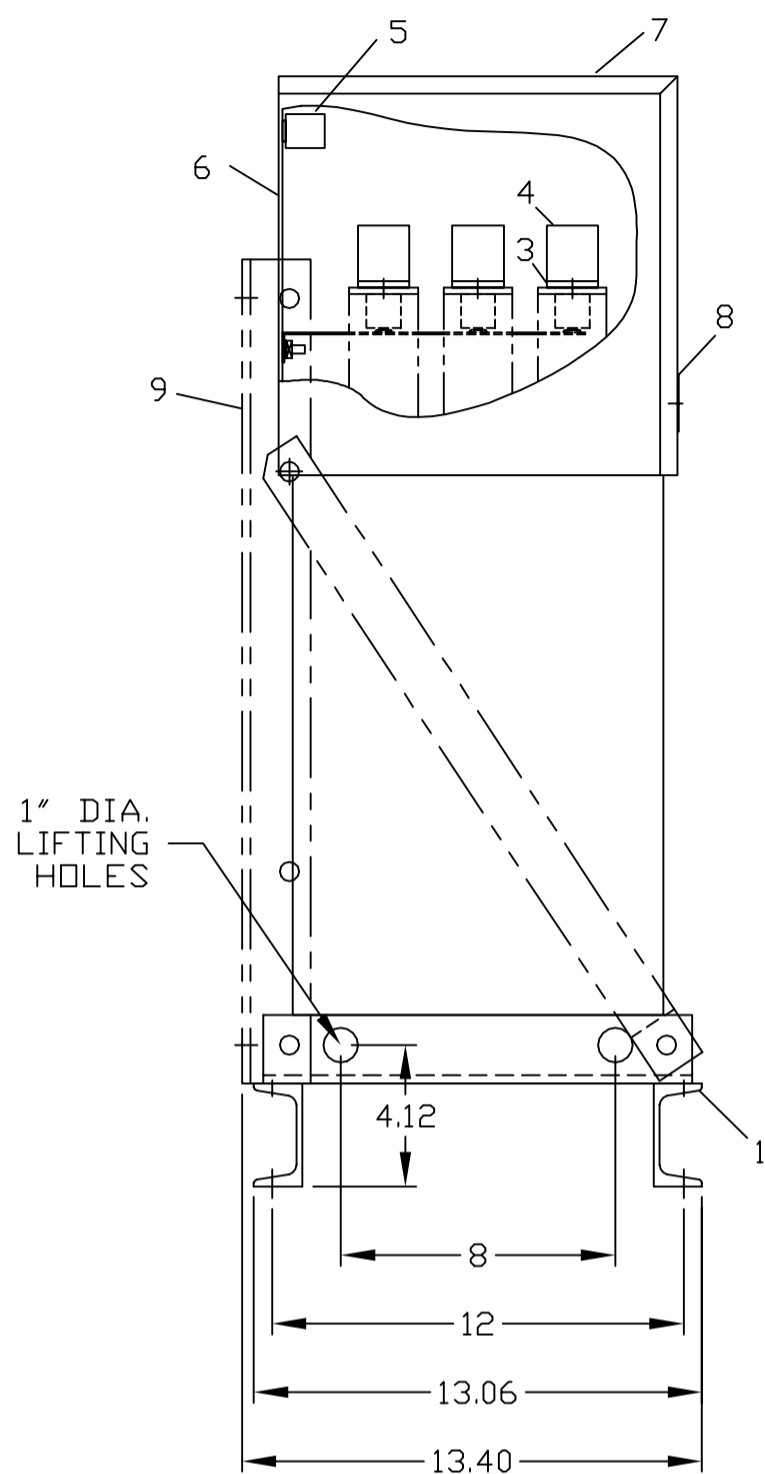

NOMENCLATURE

- 1. ALUMINUM BASE FRAME
- 2. CAPACITOR UNIT
- 3. COPPER BUS BARS
- 4. LINE TERMINAL - #4/0 TO 600 MCM
- 5. GROUND TERMINAL - #6AWG TO 250 MCM
- 6. BUS ENCLOSURE
- 7. ACCESS COVER
- 8. RATING NAMEPLATE
- 9. OPTIONAL FIELD ASSEMBLED WALL MTG. FRAME

SECT. 1
COMMON
SECT. 2

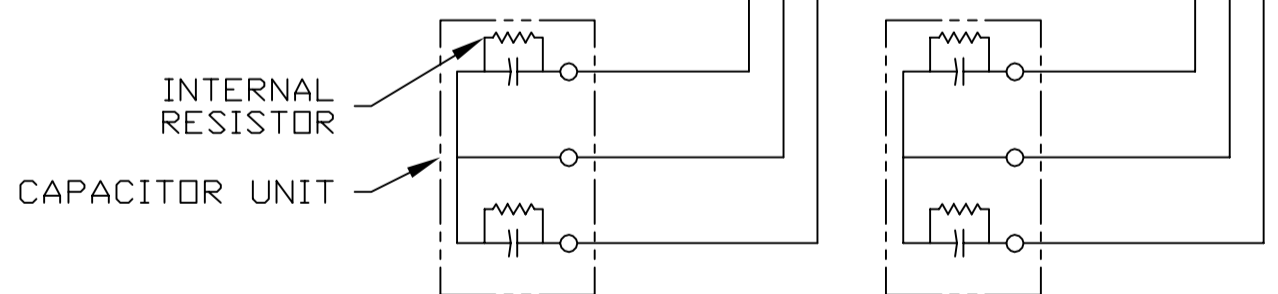

CONNECTION DIAGRAM

CAT 65L918TR2 SERNO
 KVAR 140 60Hz 1ph
 VOLT 480 DIAG 186C3233EN
 CONN COM CTR
 Read instructions: GEH-2728

SIGNATURES		DATE
DRAWN E.McGINN		9/24/92
CHECKED		
ENGR		
ISSUED		9/30/93
CAD SYS. NO.		
AUTOCAD		



INDUSTRIAL SYSTEMS
FORT EDWARD, N.Y., U.S.A.

OUTLINE
65L918TR2

FIRST MADE FOR:

SIZE	FSCM NO.	DWG NO.	REV
C		65L918TR2	1
SCALE	SHEET	CONT ON SHT	

413

DISTR TO

4

3

2

1