

REVISIONS

REV	DESCRIPTION	DATE	APPROVED
1	UPDATE TO AUTOCAD		KS

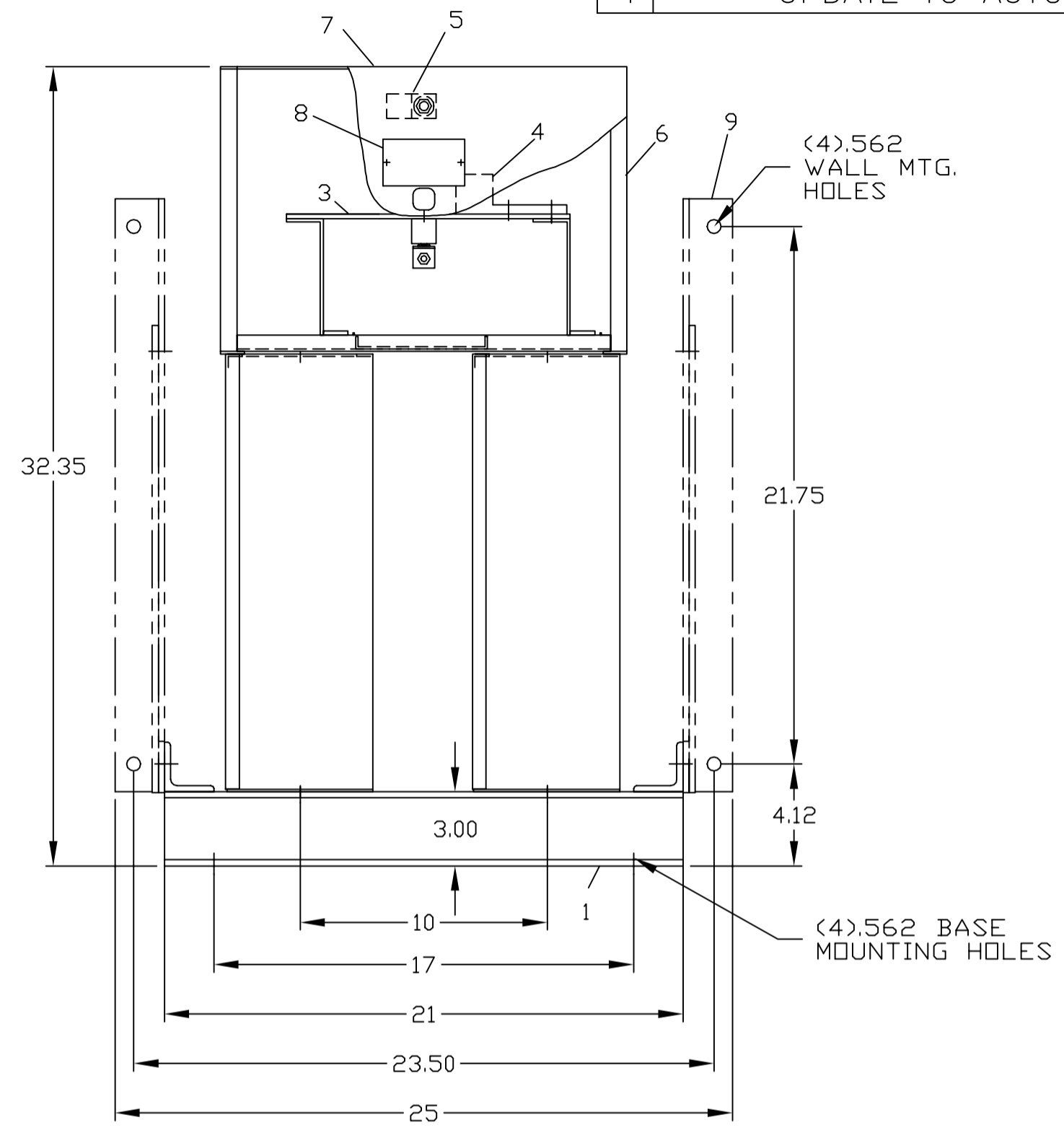
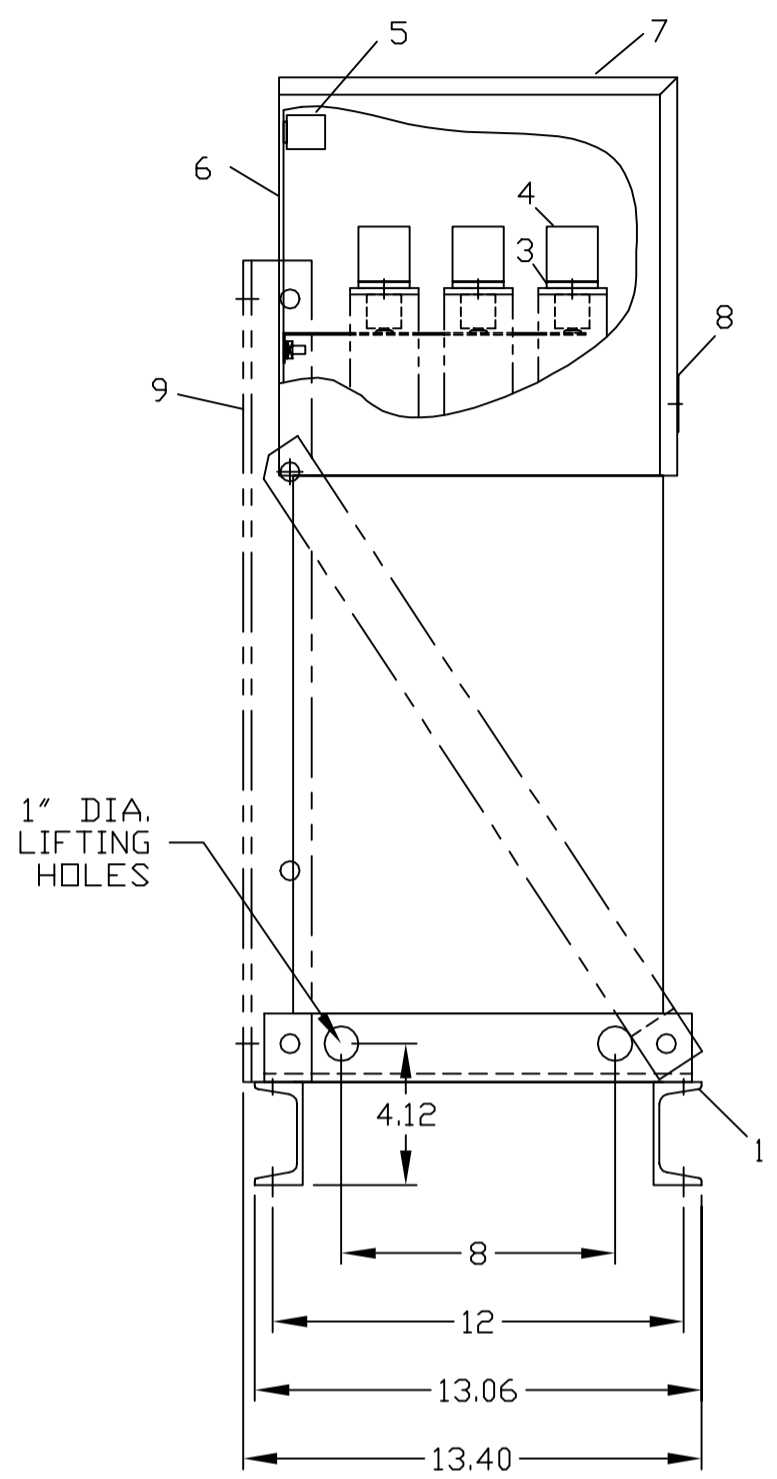

NOMENCLATURE

- 1. ALUMINUM BASE FRAME
- 2. CAPACITOR UNIT
- 3. COPPER BUS BARS
- 4. LINE TERMINAL - #4/0 TO 600 MCM
- 5. GROUND TERMINAL - #6AWG TO 250 MCM
- 6. BUS ENCLOSURE
- 7. ACCESS COVER
- 8. RATING NAMEPLATE
- 9. OPTIONAL FIELD ASSEMBLED WALL MTG. FRAME

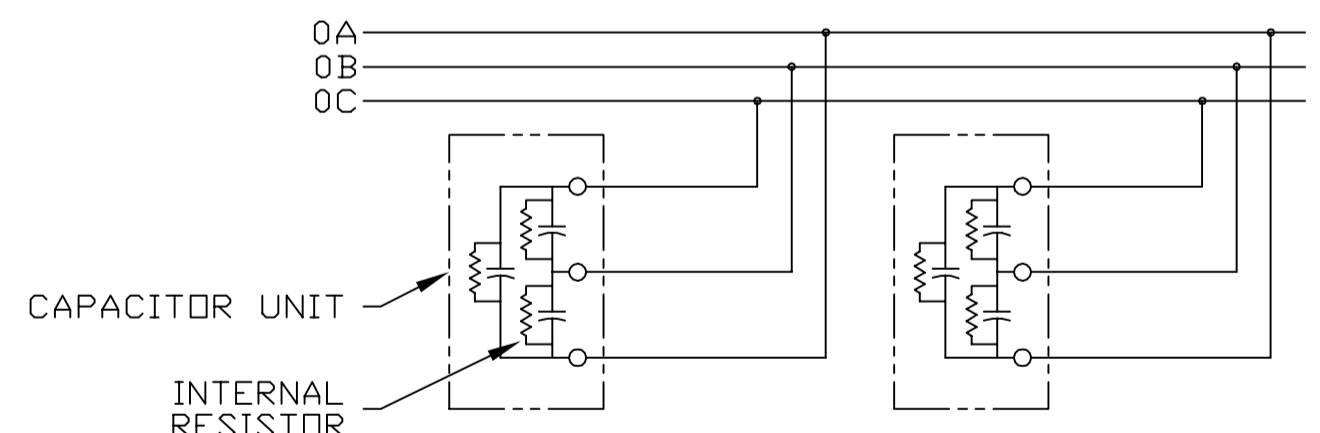

CONNECTION DIAGRAM

CAT	65L919TA2	SERNO	
KVAR	150	60Hz	3ph
VOLT	480	DIAG	186C3233EM
		CONN	DELTA

Read instructions: GEH-2728

SIGNATURES	DATE
DRAWN E.McGINN	9/24/92
CHECKED	
ENGR	
ISSUED	9/30/93
CAD SYS. NO.	
AUTOCAD	



INDUSTRIAL SYSTEMS
FORT EDWARD, N.Y., U.S.A.

OUTLINE
65L919TA2

FIRST MADE FOR:

SIZE	FSCM NO.	DWG NO.	REV
C		65L919TA2	1
SCALE	SHEET	CONT ON SHT	

413
DISTR TO