

SIZE A	DWG NO 65L920TF3	SHT 2	REV
REV	DESCRIPTION	DATE	APPROVED

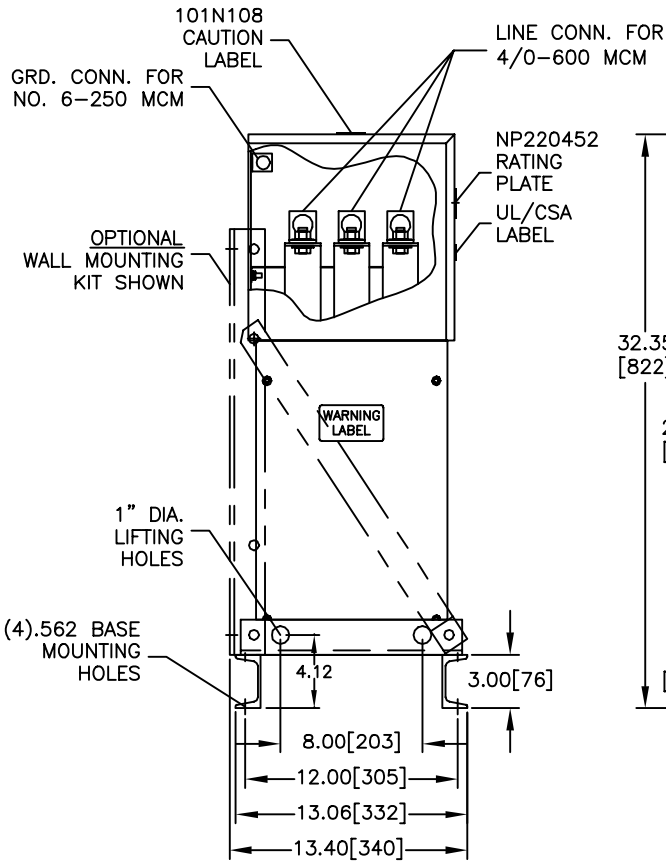

FRONT VIEW
SHOWN WITH TOP/FRONT COVER REMOVED

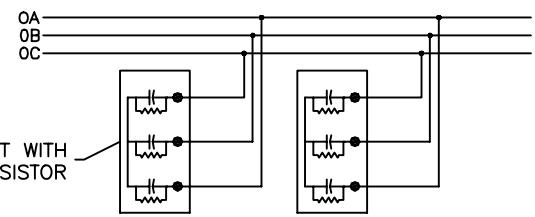
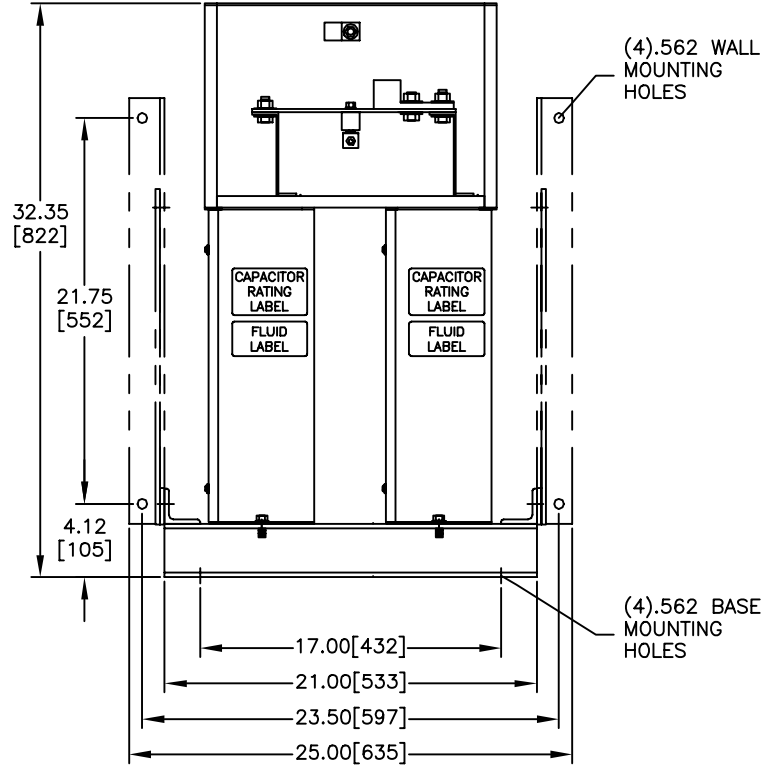

CONNECTION DIAGRAM

CAPACITOR

CAT. 65L920TF3 SER.NO.

kVAR 160 60 Hz 3 Ph

VOLT. 600 CONN. WYE

DIAG. 186C3233EL

CAUTION BEFORE INSTALLING OR OPERATING READ INST. 2738

CAPACITOR UNITS CONTAIN CLASS III B COMBUSTIBLE LIQUID.
CAPACITOR UNITS INCLUDE INTERNAL DISCHARGE RESISTORS.
NP220452 FORT EDWARD, N.Y. MADE IN U.S.A.

INDUSTRIAL SYSTEMS FORT EDWARD, N.Y., U.S.A.	SIZE A	EST. WEIGHT: 97	<h1 style="margin: 0;">OUTLINE</h1> <h1 style="margin: 0;">65L920TF3</h1>
	DRAWN A.Cozzens DATE 6/26/2003	GALLONS LIQUID: 1.32	
ISSUED	DATE 7/9/2003	SHEET 2 CONT ON -	DISTR. TO