

REVISIONS			
REV	DESCRIPTION	DATE	APPROVED
1	UPDATE TO AUTOCAD		EJM

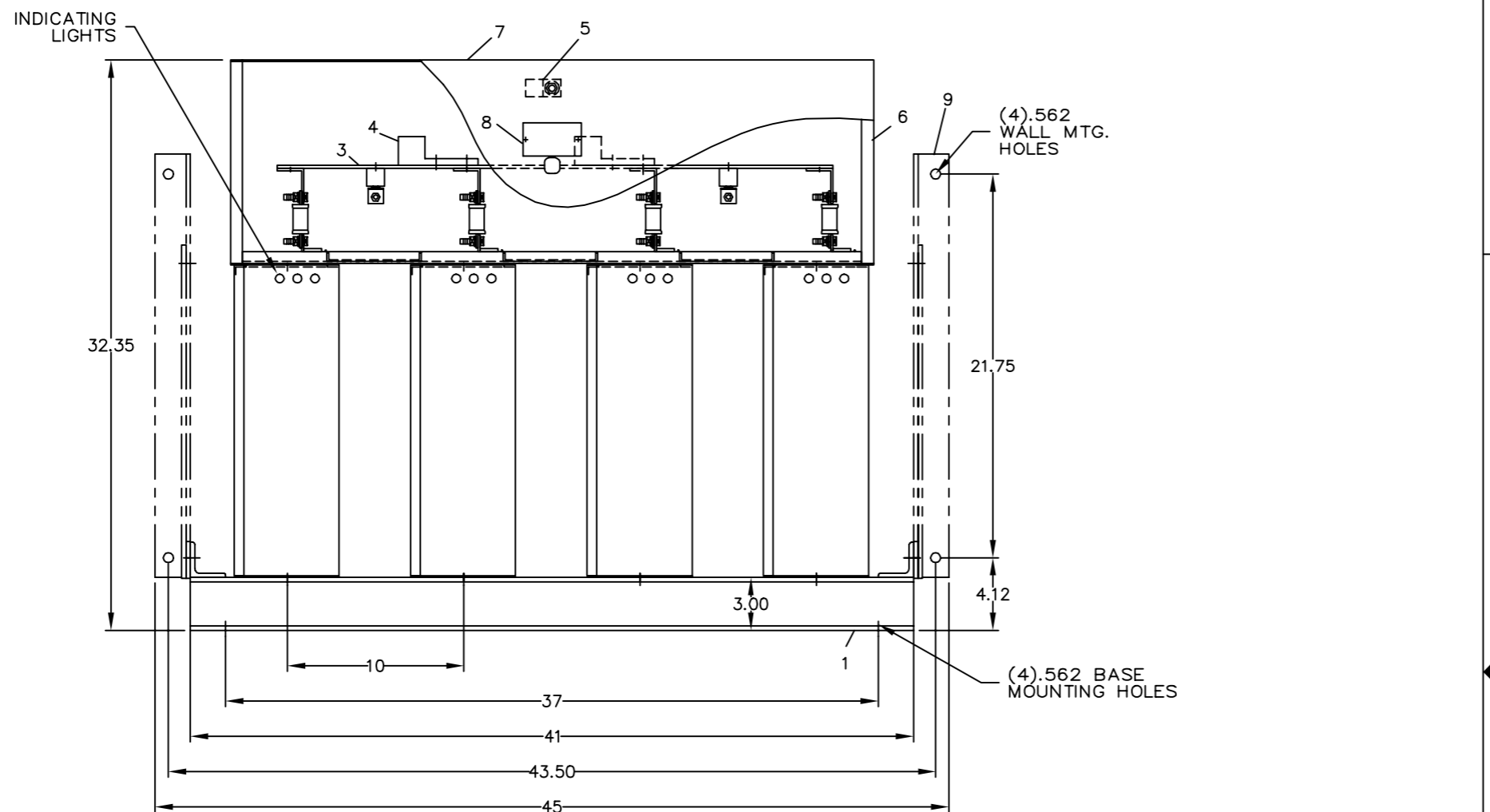

- NOMENCLATURE**
1. ALUMINUM BASE FRAME
 2. CAPACITOR UNIT
 3. COPPER BUS BARS
 4. LINE TERMINAL - #4/0 TO 600 MCM
 5. GROUND TERMINAL - #6AWG TO 250 MCM
 6. BUS ENCLOSURE
 7. ACCESS COVER
 8. RATING NAMEPLATE
 9. OPTIONAL FIELD ASSEMBLED WALL MTG. FRAME

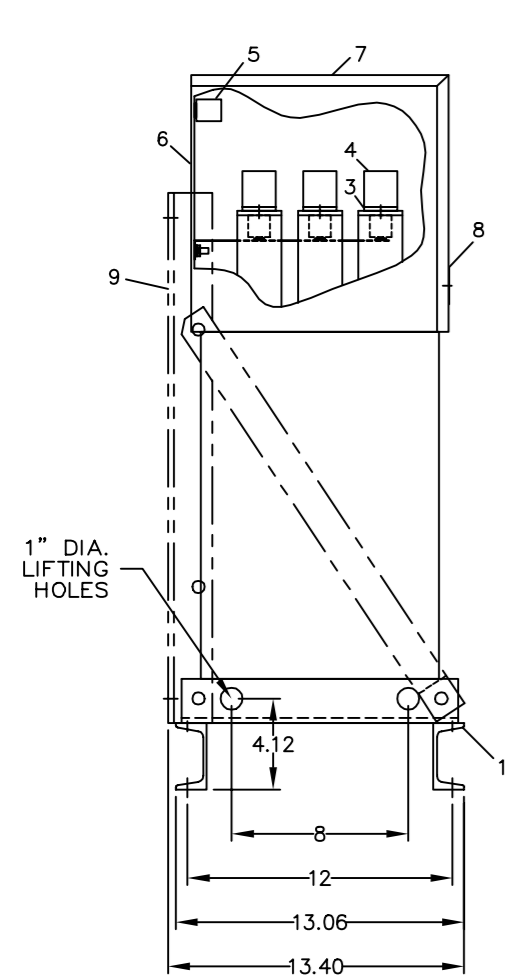
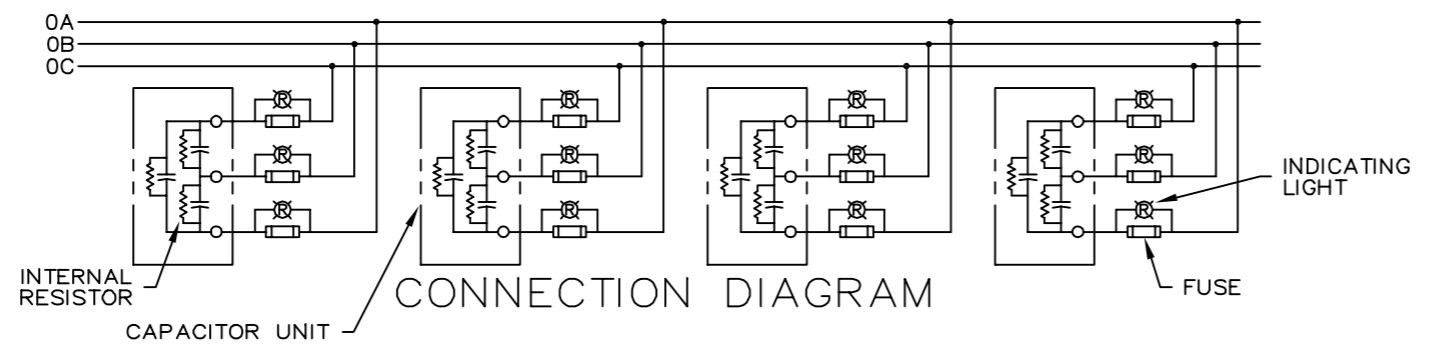

SIGNATURES		DATE		INDUSTRIAL SYSTEMS FORT EDWARD, N.Y., U.S.A. OUTLINE 65L920TQ2 FIRST MADE FOR:	
DRAWN E.McGINN		9/30/93			
CHECKED					
ENGR					
ISSUED		9/30/93			
CAD SYS. NO.		SIZE C	FSCM NO.	DWG NO. 65L920TQ2	REV 1
AUTOCAD		SCALE		SHEET 1	CONT ON SHT -

CAT 65L920TQ2 SERNO
 KVAR 160 60Hz 3ph
 VOLT 240 DIAG 186C3233GB
 CONN DELTA
 Read instructions: GEH-2728

413

DISTR TO