

4

3

2

C

SIZE DWG NO.

SHT

REV

1

1

65L922TC2

REVISIONS

REV	DESCRIPTION	DATE	APPROVED
1	UPDATE TO AUTOCAD		KS

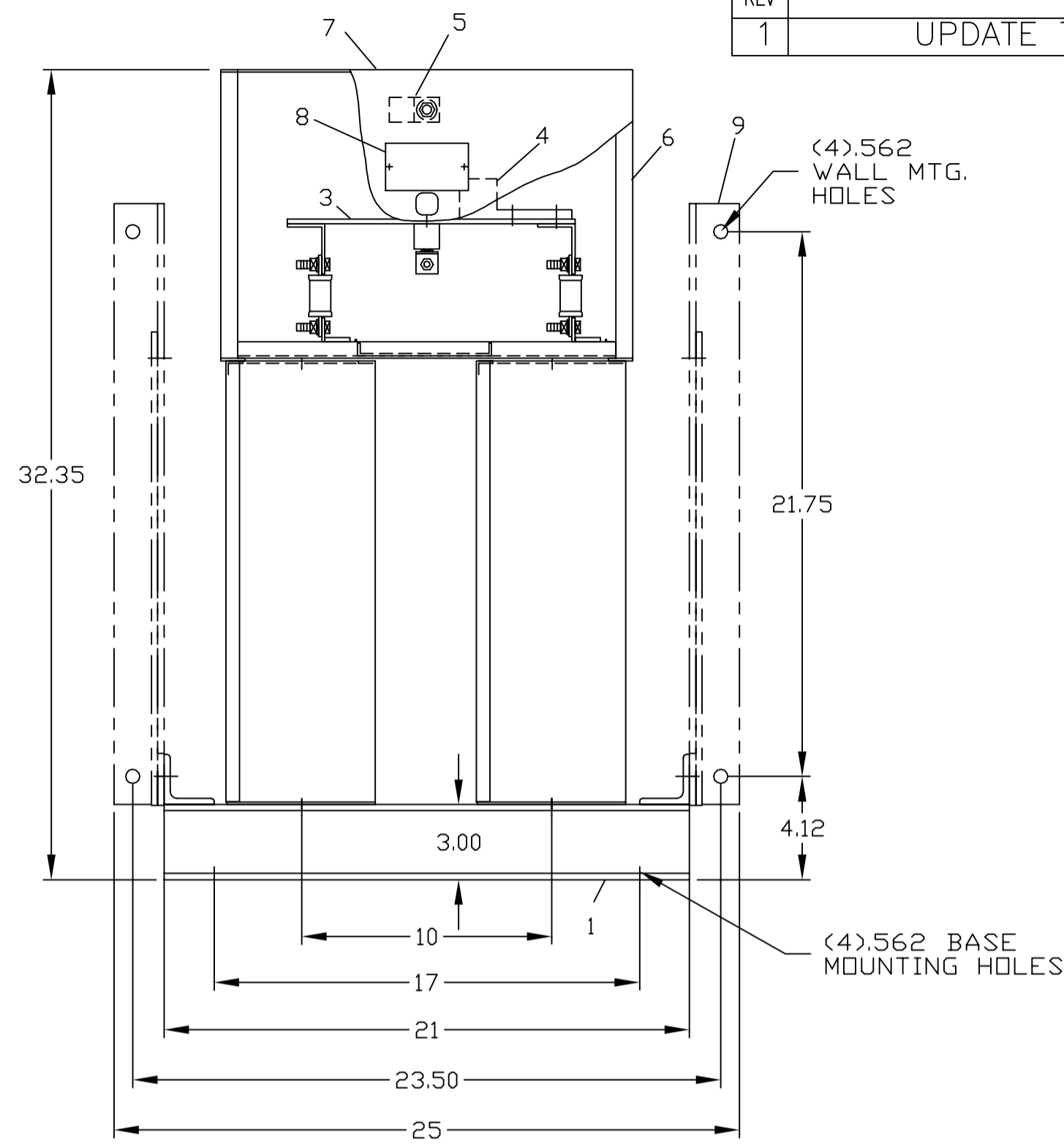
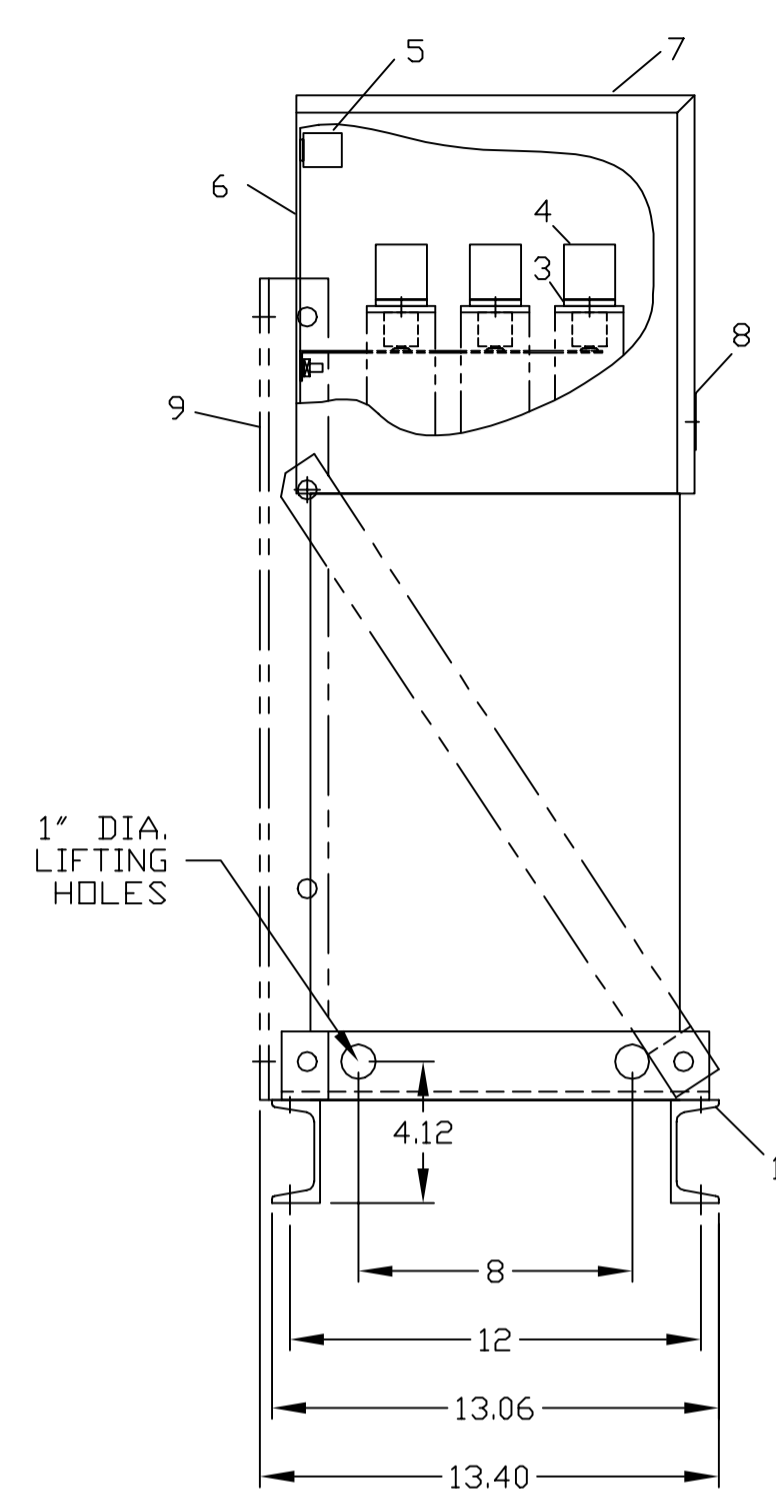

NOMENCLATURE

- 1. ALUMINUM BASE FRAME
- 2. CAPACITOR UNIT
- 3. COPPER BUS BARS
- 4. LINE TERMINAL - #4/0 TO 600 MCM
- 5. GROUND TERMINAL - #6AWG TO 250 MCM
- 6. BUS ENCLOSURE
- 7. ACCESS COVER
- 8. RATING NAMEPLATE
- 9. OPTIONAL FIELD ASSEMBLED WALL MTG. FRAME

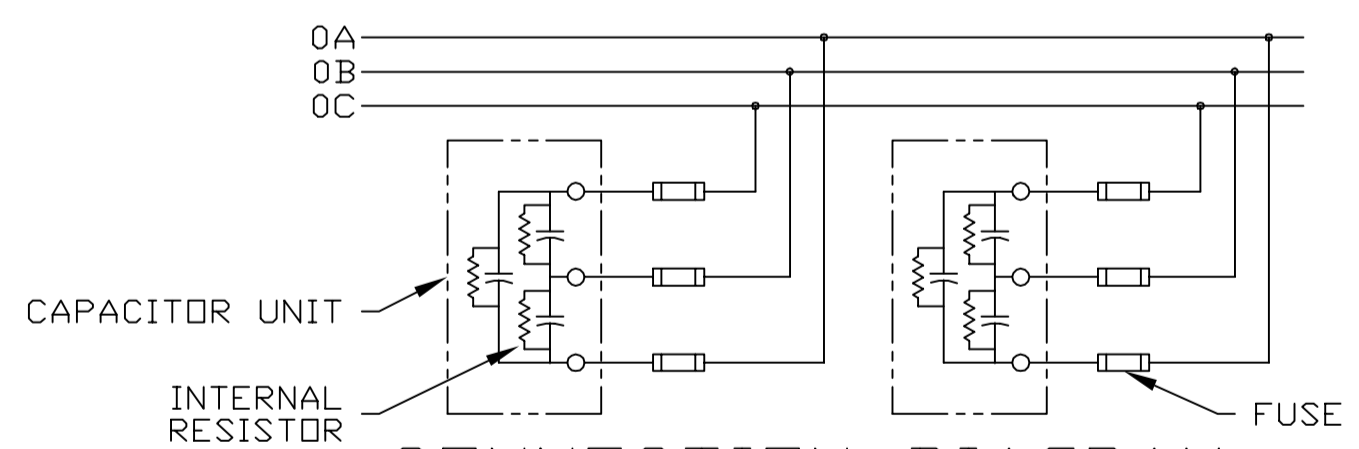

CONNECTION DIAGRAM

CAT 65L922TC2 SERNO
 KVAR 175 60Hz 3ph
 VOLT 480 DIAG 186C3233ED
 CONN DELTA
 Read instructions: GEH-2728

SIGNATURES		DATE		INDUSTRIAL SYSTEMS FORT EDWARD, N.Y., U.S.A. OUTLINE 65L922TC2 FIRST MADE FOR:	
DRAWN E.McGINN		9/24/92			
CHECKED					
ENGR					
ISSUED		9/30/93			
CAD SYS. NO.		SIZE C	FSCM NO.	DWG NO. 65L922TC2	REV 1
AUTOCAD		SCALE	SHEET	CONT ON SHT	DISTR TO

413

4

3

2

1