

SIZE	DWG NO.	SHT	REV	REV
C	65L923TX2	1	1	1
REVISIONS				
REV	DESCRIPTION	DATE	APPROVED	
1	UPDATE TO AUTOCAD		FWL	

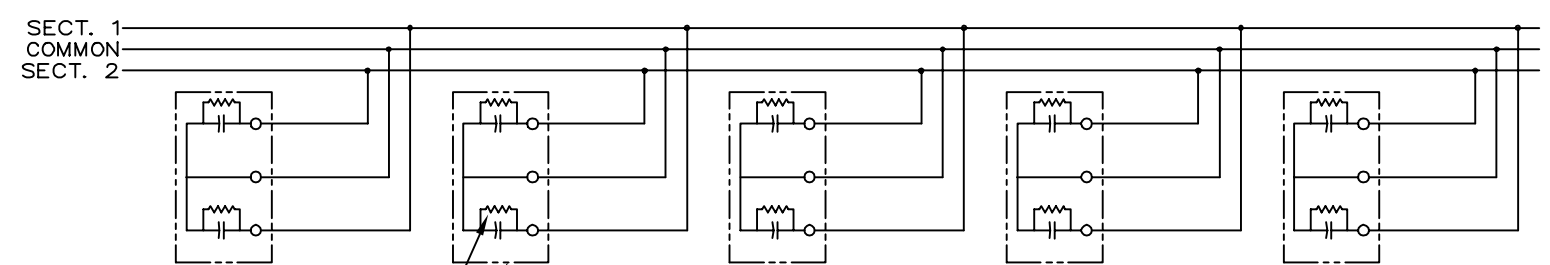
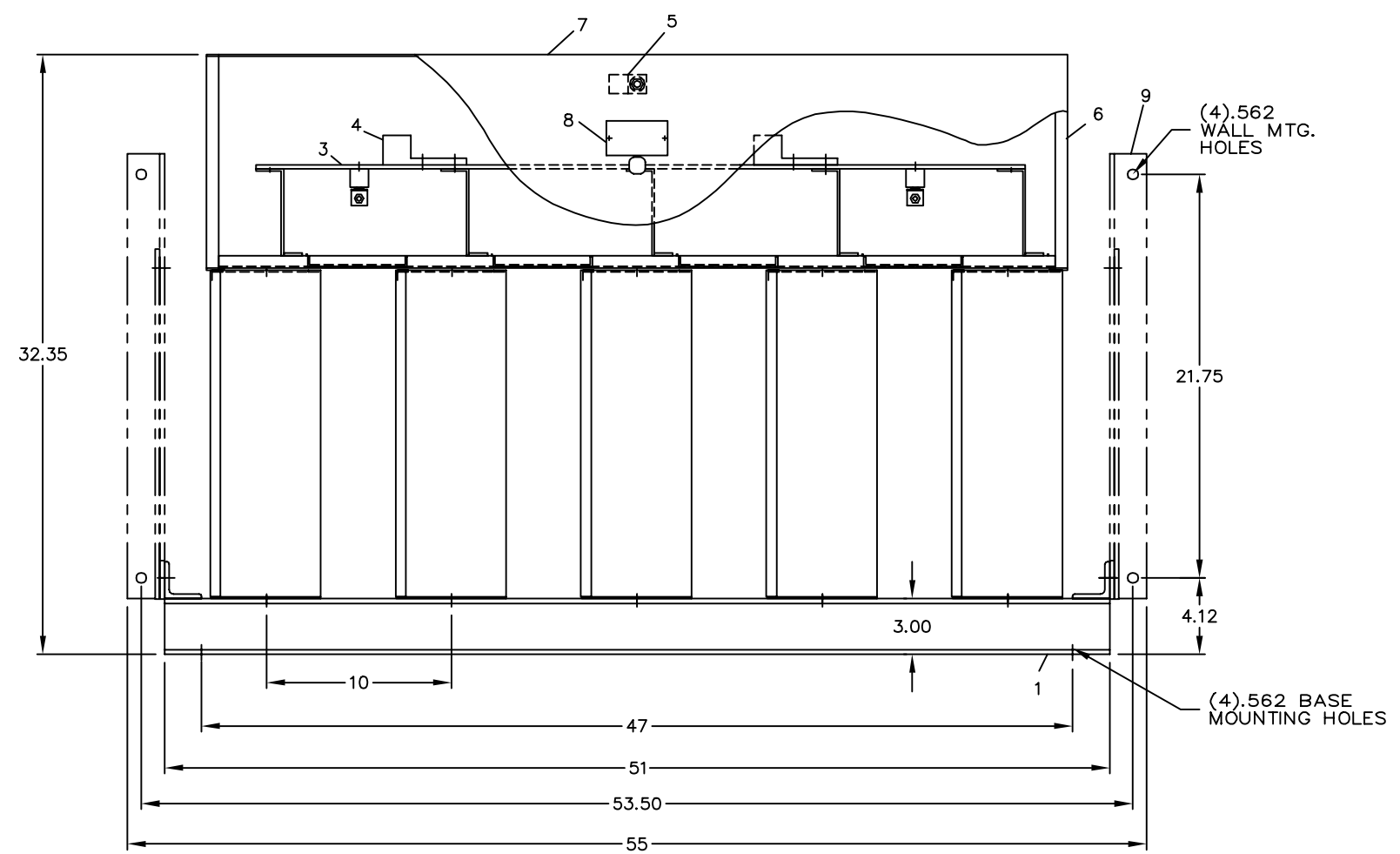
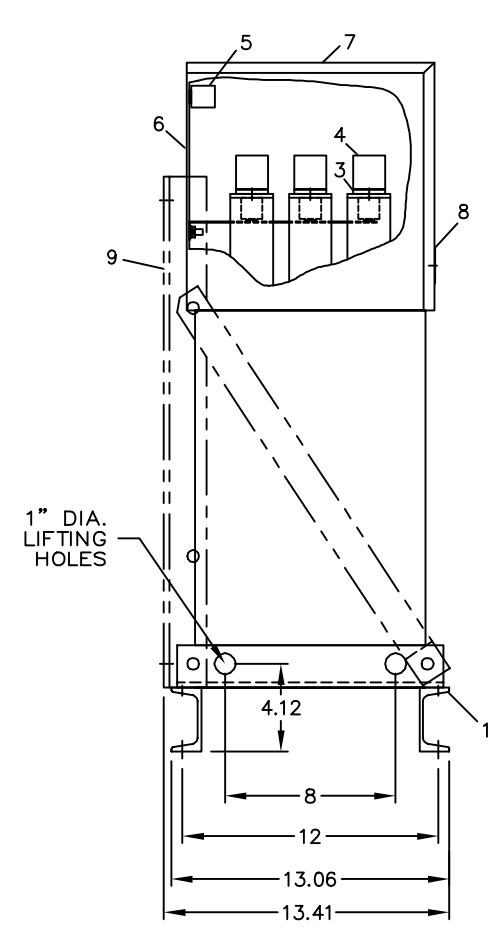

- NOMENCLATURE**
1. ALUMINUM BASE FRAME
 2. CAPACITOR UNIT
 3. COPPER BUS BARS
 4. LINE TERMINAL - #4/0 TO 600 MCM
 5. GROUND TERMINAL - #6AWG TO 250 MCM
 6. BUS ENCLOSURE
 7. ACCESS COVER
 8. RATING NAMEPLATE
 9. OPTIONAL FIELD ASSEMBLED WALL MTG. FRAME

CONNECTION DIAGRAM

SIGNATURES		DATE		INDUSTRIAL SYSTEMS FORT EDWARD, N.Y., U.S.A.	
DRAWN E.MCGINN		10/2/92			
CHECKED				OUTLINE 65L923TX2	
ENGR					
ISSUED		9/30/93			
CAD SYS. NO.		SIZE	FSCM NO.	DWG NO.	REV
AUTOCAD		C		65L923TX2	1
		SCALE	SHEET 1		CONT ON SHT -

CAT 65L923TX2 SERNO
KVAR 180 60Hz 1ph
VOLT 240 DIAG 186C3233HN
CDNN CDM CTR

Read instructions: GEH-2728

413

DISTR TO