

SIZE A	DWG NO 65L923TX3	SHT 2	REV
REV	DESCRIPTION	DATE	APPROVED

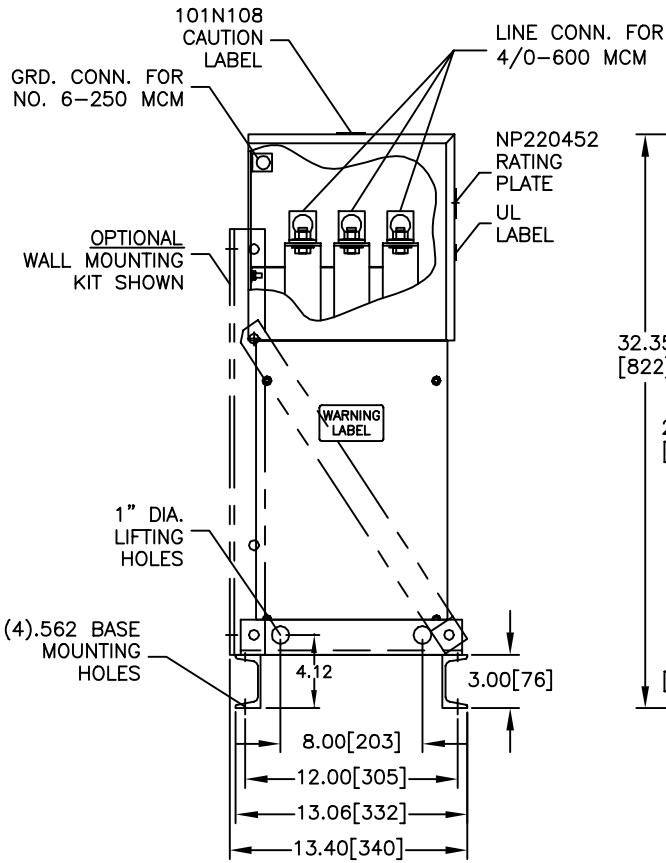

FRONT VIEW
SHOWN WITH TOP/FRONT COVER REMOVED

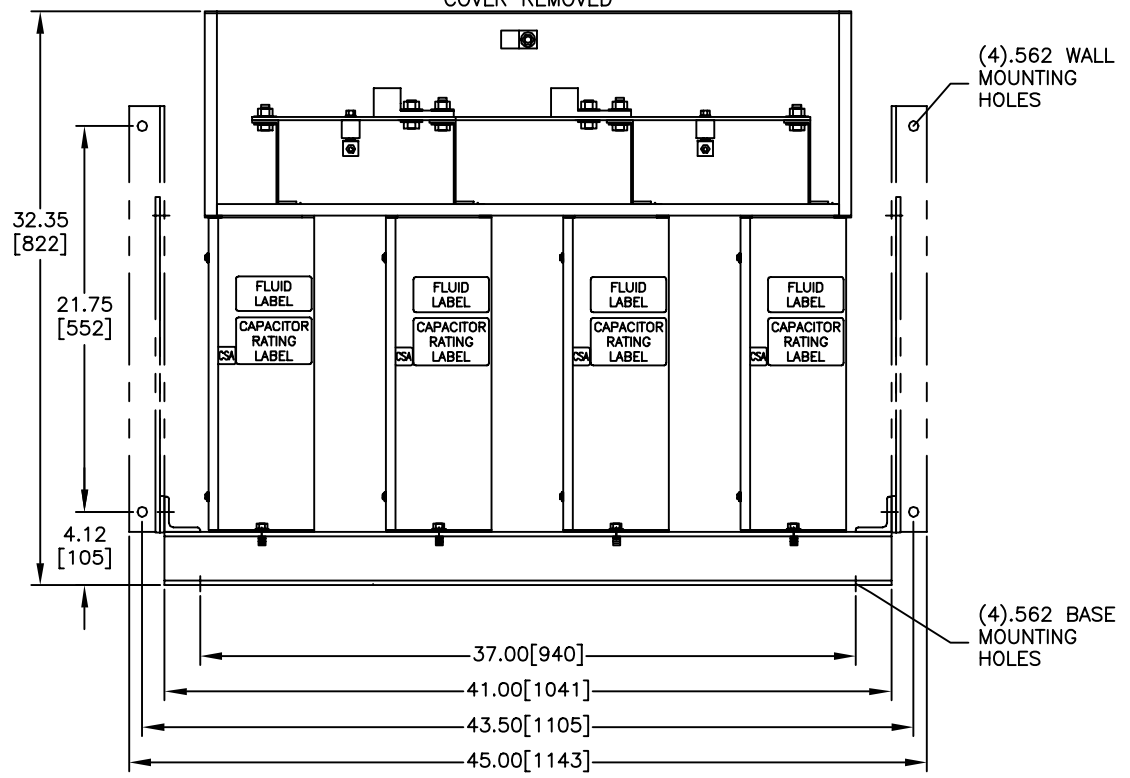

CAPACITOR

CAT. 65L923TX3 SER.NO.
 kVAR 180 60 Hz 1 Ph
 VOLT. 240 CONN. COM CTR
 DIAG. 186C3233GN

CAUTION BEFORE INSTALLING OR OPERATING READ INST. 2738
 CAPACITOR UNITS CONTAIN CLASS III B COMBUSTIBLE LIQUID.
 CAPACITOR UNITS INCLUDE INTERNAL DISCHARGE RESISTORS.
 NP220452 FORT EDWARD, N.Y. MADE IN U.S.A.

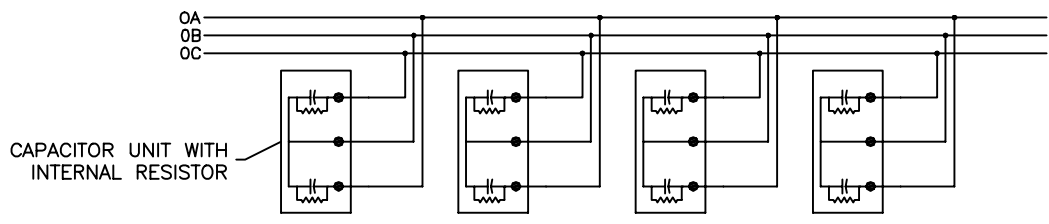

CONNECTION DIAGRAM

INDUSTRIAL SYSTEMS FORT EDWARD, N.Y., U.S.A.	SIZE A	EST. WEIGHT: 196	<h1 style="margin: 0;">OUTLINE</h1> <h2 style="margin: 0;">65L923TX3</h2>
	SCALE	GALLONS LIQUID: 1.84	
DRAWN B.Ross	DATE 8/8/2003	SHEET 2	CONT ON —
ISSUED	DATE 8/13/2003		

DISTR. TO