

4

3

2

C

SIZE DWG NO.

65L925TS2

SHT

REV 1

1

REVISIONS			
REV	DESCRIPTION	DATE	APPROVED
1	UPDATE TO AUTOCAD		KS

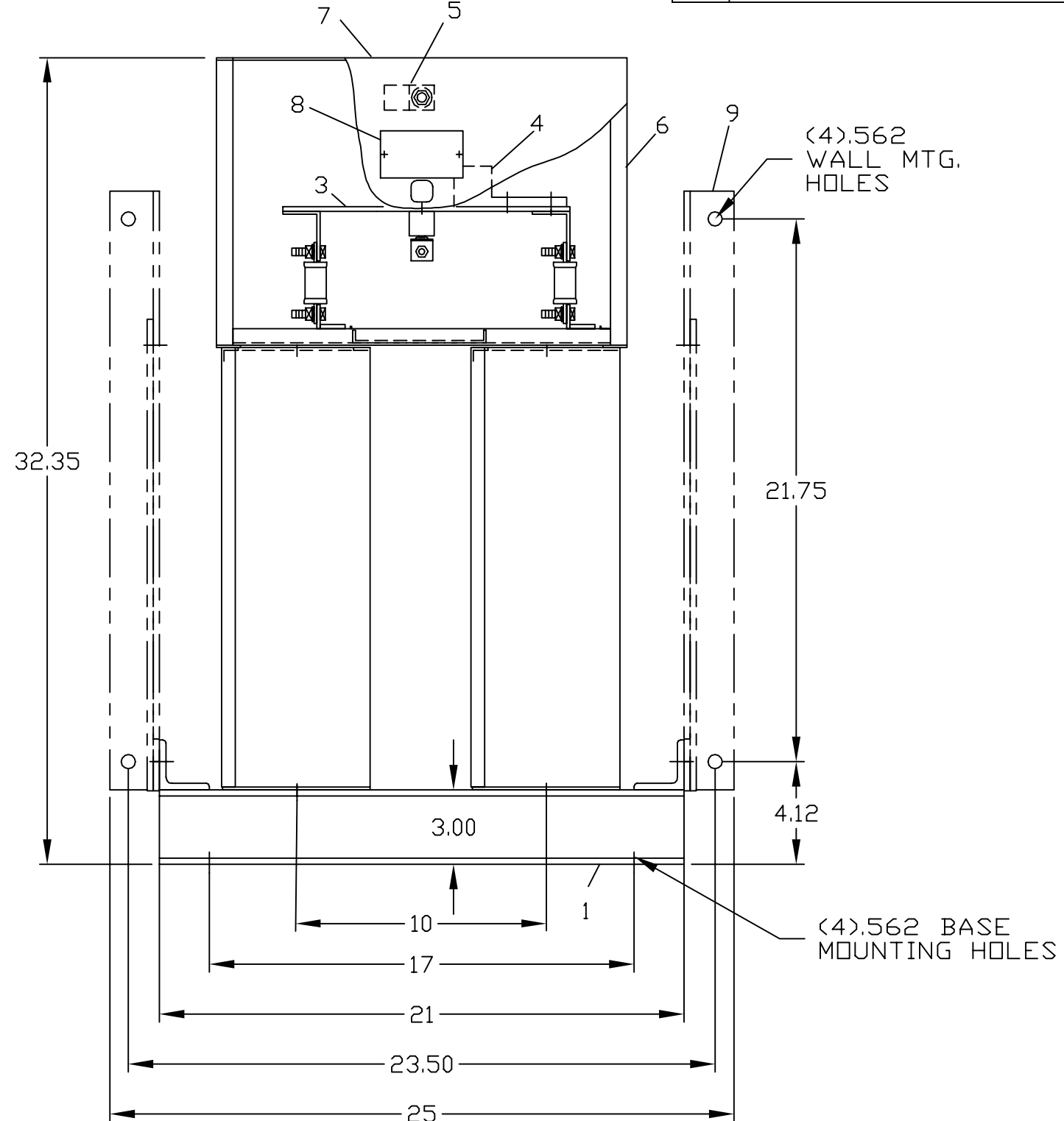
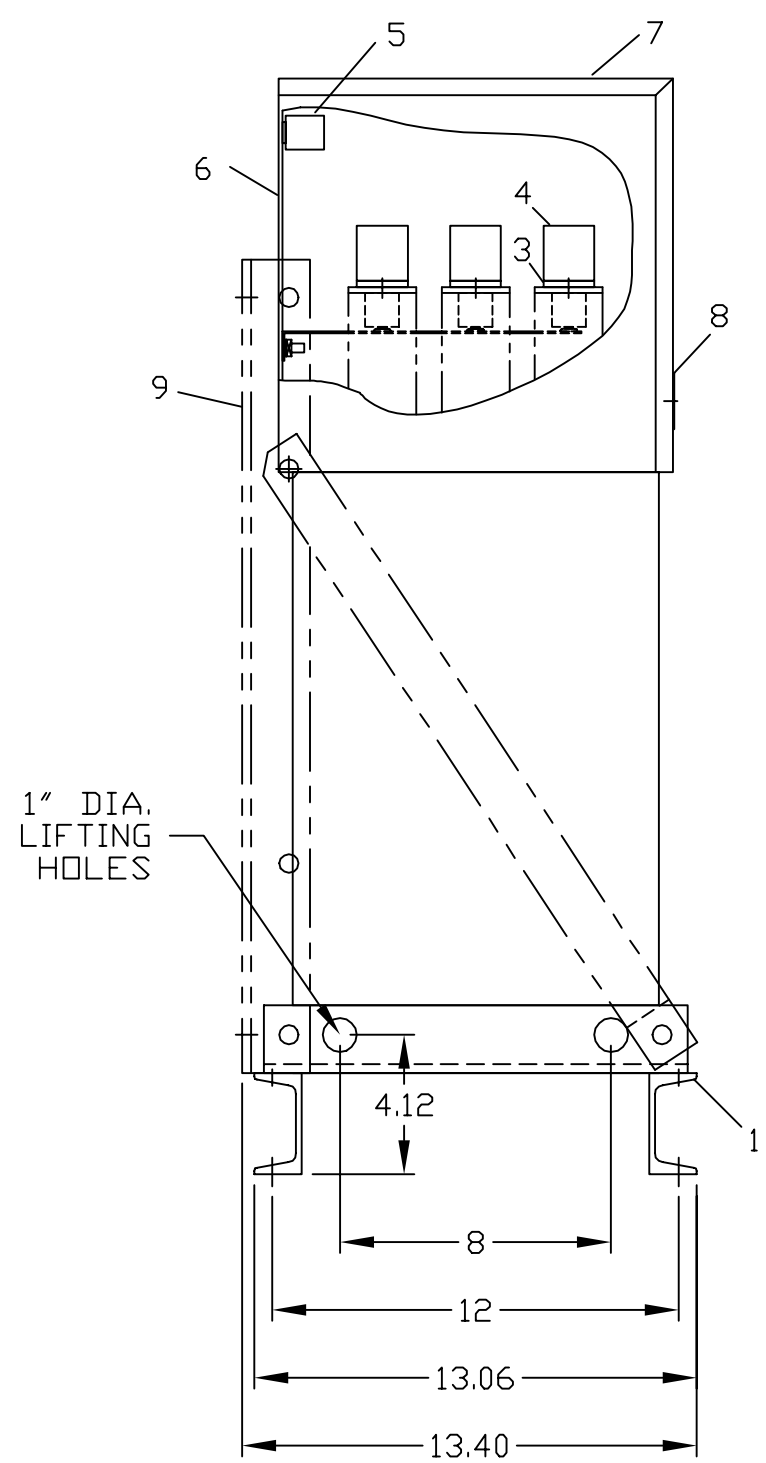

NOMENCLATURE

- 1. ALUMINUM BASE FRAME
- 2. CAPACITOR UNIT
- 3. COPPER BUS BARS
- 4. LINE TERMINAL - #4/0 TO 600 MCM
- 5. GROUND TERMINAL - #6AWG TO 250 MCM
- 6. BUS ENCLOSURE
- 7. ACCESS COVER
- 8. RATING NAMEPLATE
- 9. OPTIONAL FIELD ASSEMBLED WALL MTG. FRAME

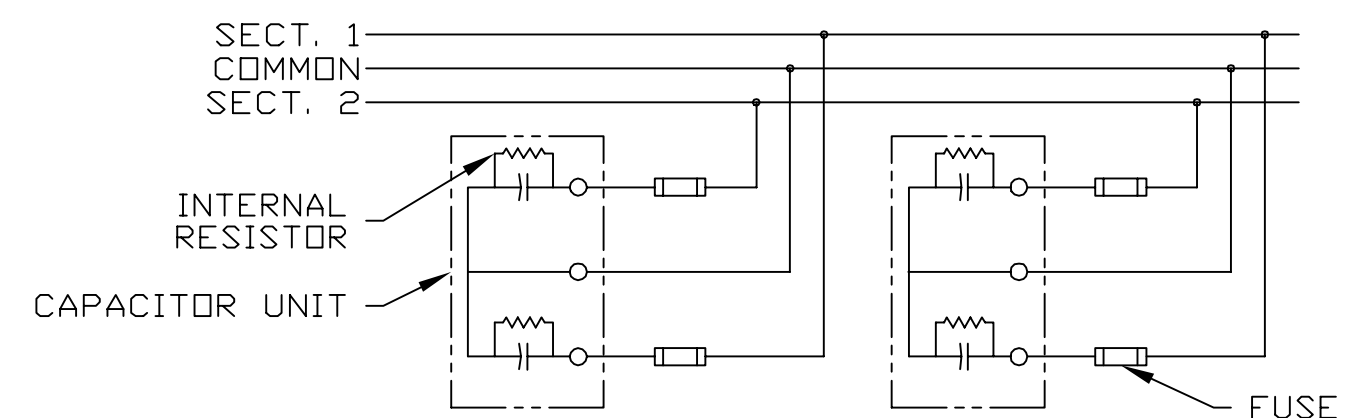

CONNECTION DIAGRAM

CAT 65L925TS2 SERNO  
 KVAR 200 60Hz 1ph  
 VOLT 480 DIAG 186C3233EK  
 CONN COM CTR  
 Read instructions: GEH-2728

SIGNATURES	DATE
DRAWN E.McGINN	9/24/92
CHECKED	
ENGR	
ISSUED	9/30/93
CAD SYS. NO.	
AUTOCAD	



INDUSTRIAL SYSTEMS  
FORT EDWARD, N.Y., U.S.A.

OUTLINE  
65L925TS2

FIRST MADE FOR:

SIZE C	FSCM NO.	DWG NO. 65L925TS2	REV 1
SCALE	SHEET	CONT ON SHT	DISTR TO

413

4

3

2

1