

SIZE A	DWG NO 65L929TF3	SHT 2	REV
REV	DESCRIPTION	DATE	APPROVED

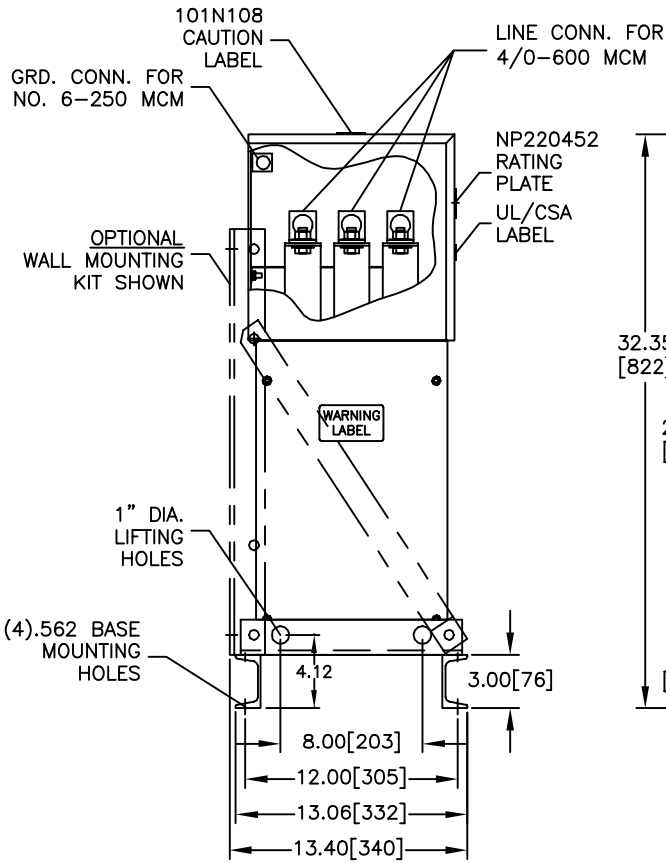

FRONT VIEW  
SHOWN WITH TOP/FRONT COVER REMOVED

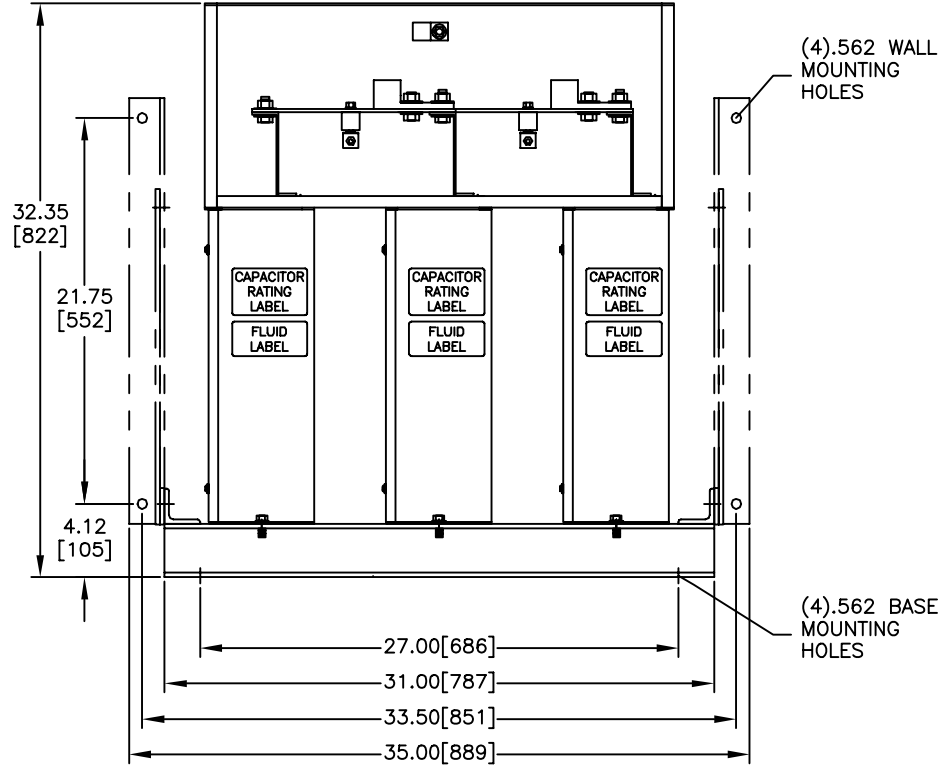

## CAPACITOR

CAT. 65L929TF3      SER.NO.  
 kVAR 240      60 Hz      3 Ph  
 VOLT. 600      CONN. WYE

DIAG. 186C3233FL

**CAUTION** BEFORE INSTALLING OR OPERATING READ INST. 2738

CAPACITOR UNITS CONTAIN CLASS III B COMBUSTIBLE LIQUID.  
 CAPACITOR UNITS INCLUDE INTERNAL DISCHARGE RESISTORS.  
 NP220452      FORT EDWARD, N.Y.      MADE IN U.S.A.

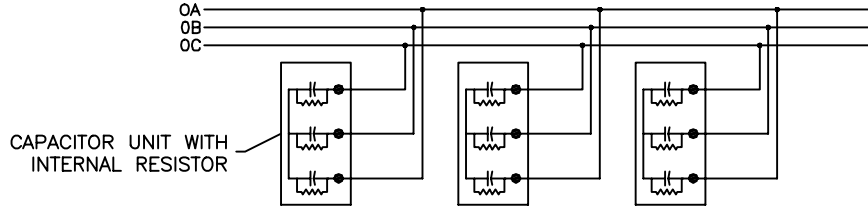

CONNECTION DIAGRAM

<b>INDUSTRIAL SYSTEMS</b> FORT EDWARD, N.Y., U.S.A.	SIZE <b>A</b>	EST. WEIGHT: 145	<h1 style="margin: 0;">OUTLINE</h1> <h2 style="margin: 0;">65L929TF3</h2>
	SCALE	GALLONS LIQUID: 1.98	
DRAWN A.Cozzens	DATE 6/26/2003	SHEET 2      CONT ON —	
ISSUED	DATE 7/9/2003		

DISTR. TO