

4

3

2

C

SIZE DWG NO.

65L937TA2

SHT 1

REV 1

1

REVISIONS			
REV	DESCRIPTION	DATE	APPROVED
1	UPDATE TO AUTOCAD		FWL

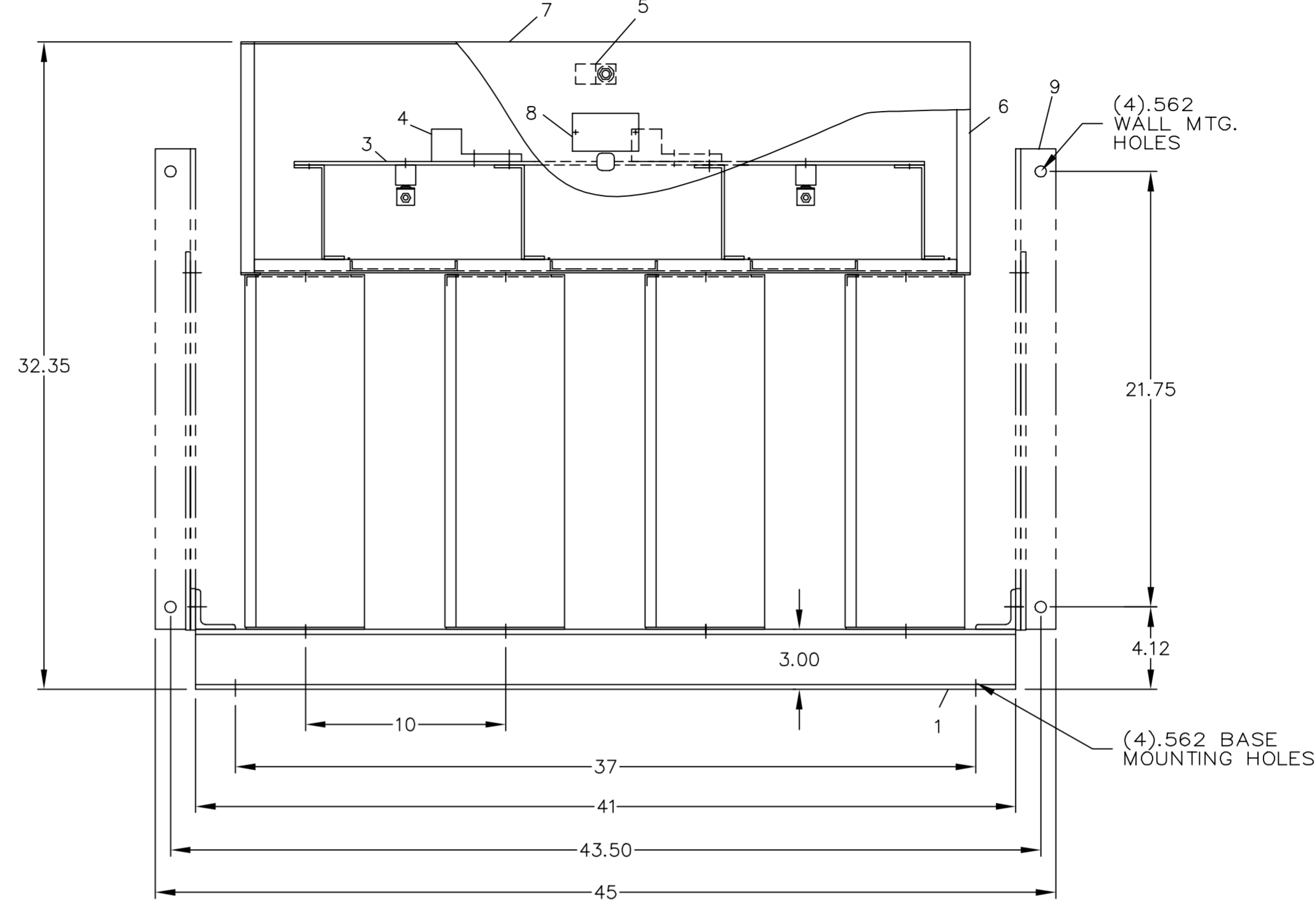
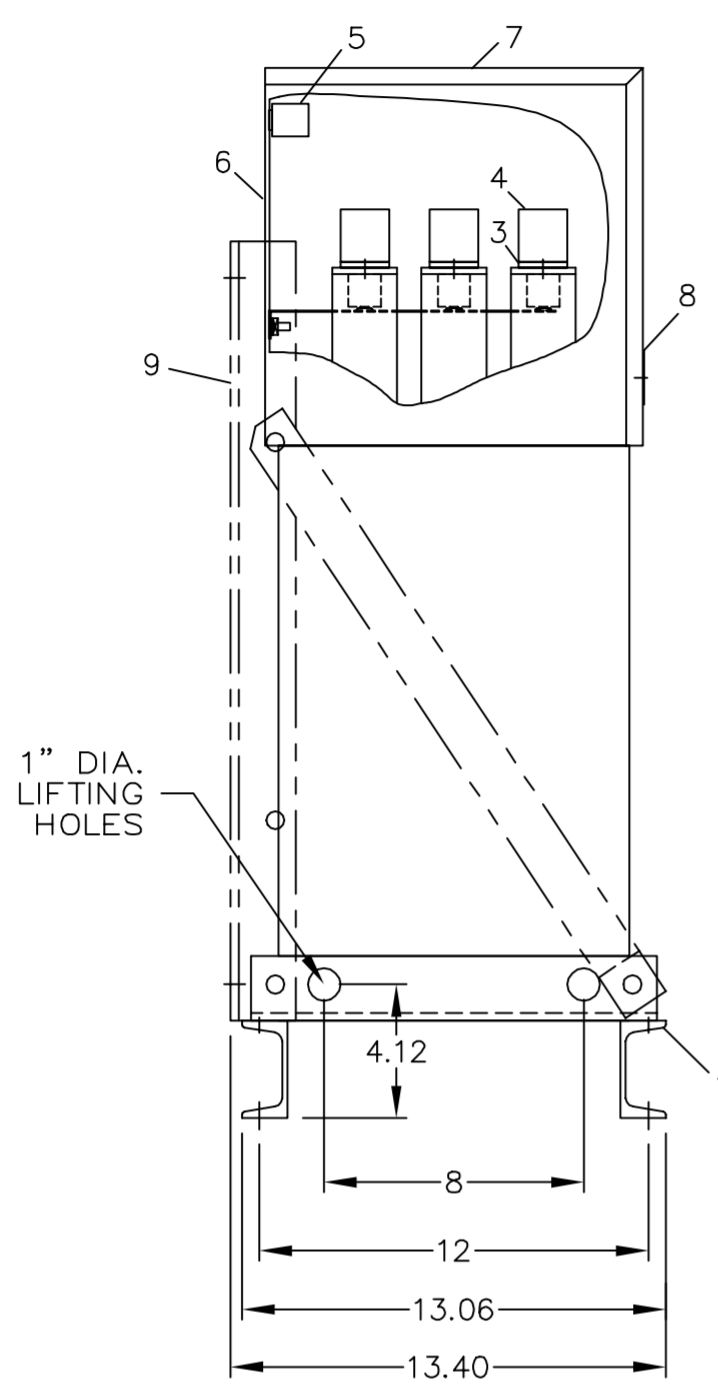

NOMENCLATURE

- 1. ALUMINUM BASE FRAME
- 2. CAPACITOR UNIT
- 3. COPPER BUS BARS
- 4. LINE TERMINAL - #4/O TO 600 MCM
- 5. GROUND TERMINAL - #6AWG TO 250 MCM
- 6. BUS ENCLOSURE
- 7. ACCESS COVER
- 8. RATING NAMEPLATE
- 9. OPTIONAL FIELD ASSEMBLED WALL MTG. FRAME

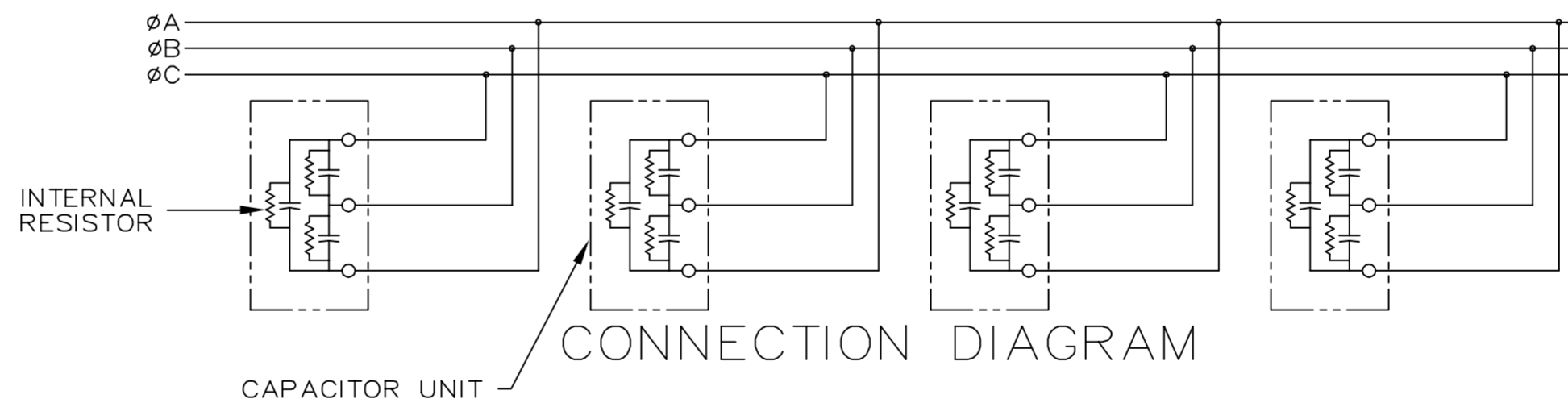

CAT 65L937TA2 SERNO
 KVAR 350 60Hz 3ph
 VOLT 480 DIAG 186C3233GM
 CONN DELTA
 Read instructions: GEH-2728

SIGNATURES		DATE
DRAWN E.McGINN		10/1/92
CHECKED		
ENGR		
ISSUED		9/30/93
CAD SYS. NO.		
AUTOCAD		



INDUSTRIAL SYSTEMS
FORT EDWARD, N.Y., U.S.A.

OUTLINE
65L937TA2

FIRST MADE FOR:

SIZE C	FSCM NO.	DWG NO. 65L937TA2	REV 1
SCALE	SHEET 1	CONT ON SHT -	DISTR TO 413