

SIZE A	DWG NO 65L937TF3	SHT 2	REV
REV	DESCRIPTION	DATE	APPROVED

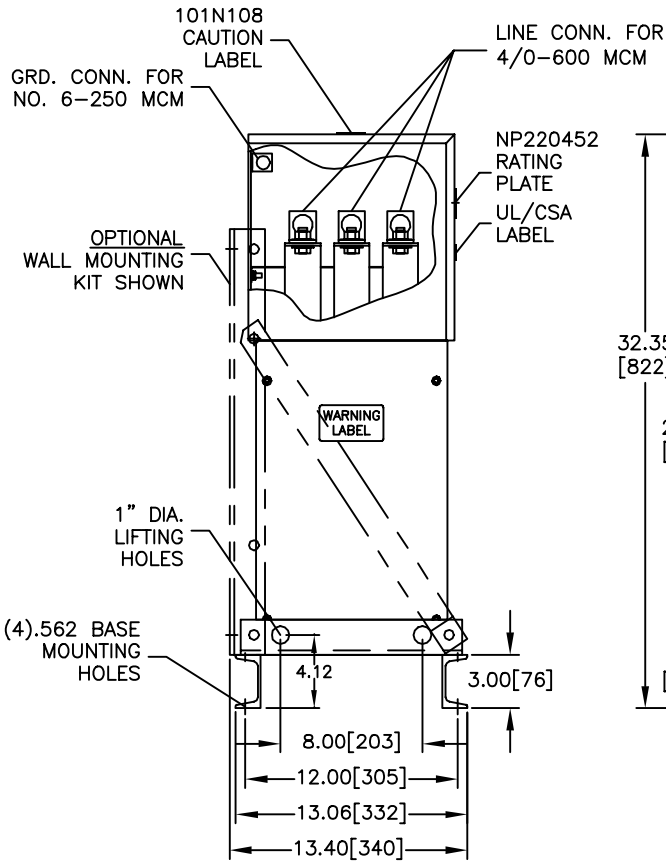

FRONT VIEW
SHOWN WITH TOP/FRONT COVER REMOVED

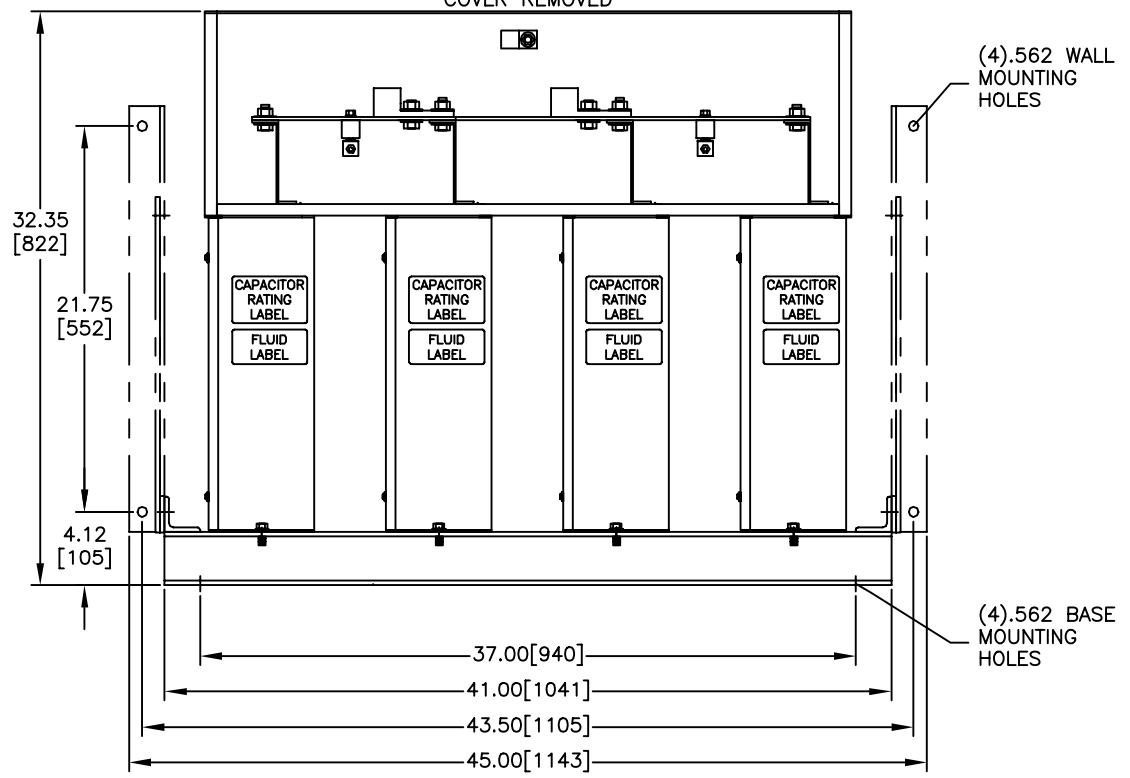

CAPACITOR

CAT. 65L937TF3 SER.NO.
 KVAR 350 60 Hz 3 Ph
 VOLT. 600 CONN. WYE
 DIAG. 186C3233GL

CAUTION BEFORE INSTALLING OR OPERATING READ INST. 2738
 CAPACITOR UNITS CONTAIN CLASS III B COMBUSTIBLE LIQUID.
 CAPACITOR UNITS INCLUDE INTERNAL DISCHARGE RESISTORS.
 NP220452 FORT EDWARD, N.Y. MADE IN U.S.A.

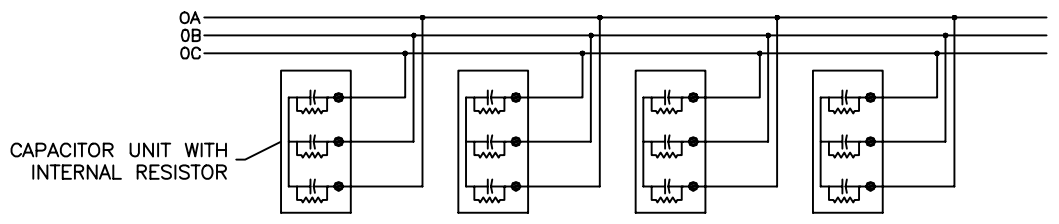

CONNECTION DIAGRAM

INDUSTRIAL SYSTEMS FORT EDWARD, N.Y., U.S.A.	SIZE A	EST. WEIGHT: 184	<h1 style="margin: 0;">OUTLINE</h1> <h2 style="margin: 0;">65L937TF3</h2>
	SCALE	GALLONS LIQUID: 1.5	
DRAWN A.Cozzens	DATE 6/27/2003		
ISSUED	DATE 7/9/2003	SHEET 2	CONT ON -

DISTR. TO