

REVISIONS			
REV	DESCRIPTION	DATE	APPROVED
1	UPDATE TO AUTOCAD		FWL

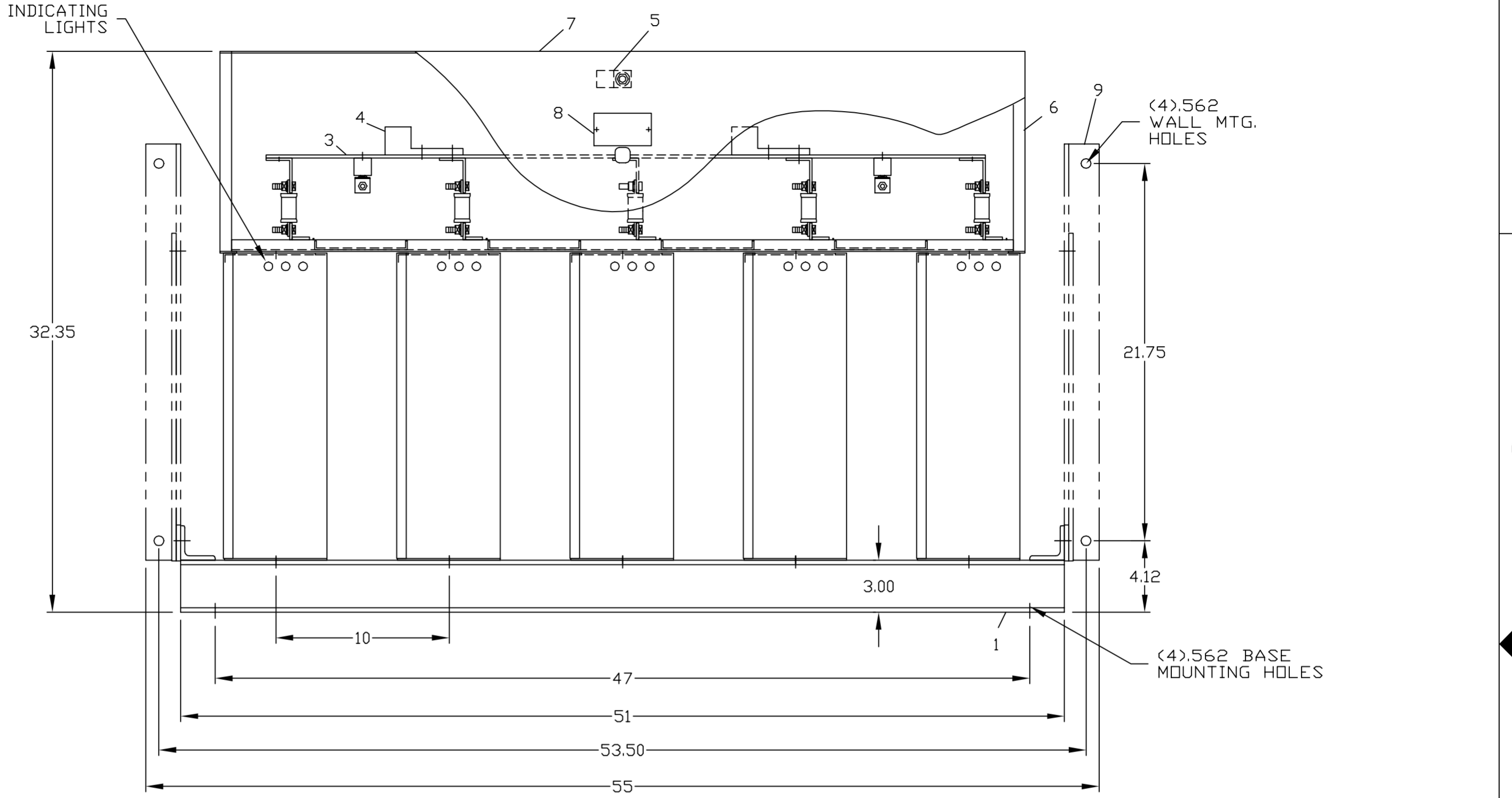

NOMENCLATURE

1. ALUMINUM BASE FRAME
2. CAPACITOR UNIT
3. COPPER BUS BARS
4. LINE TERMINAL - #4/0 TO 600 MCM
5. GROUND TERMINAL - #6AWG TO 250 MCM
6. BUS ENCLOSURE
7. ACCESS COVER
8. RATING NAMEPLATE
9. OPTIONAL FIELD ASSEMBLED WALL MTG. FRAME

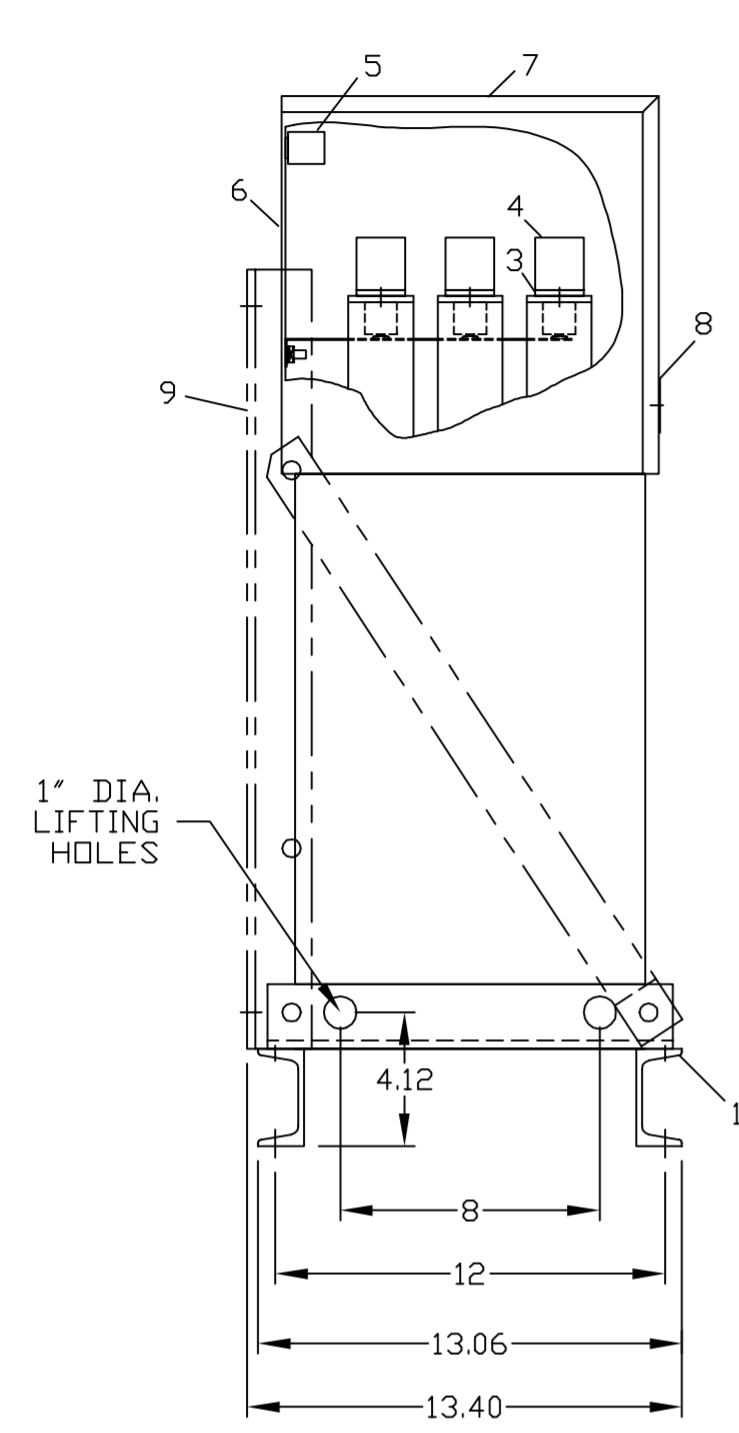
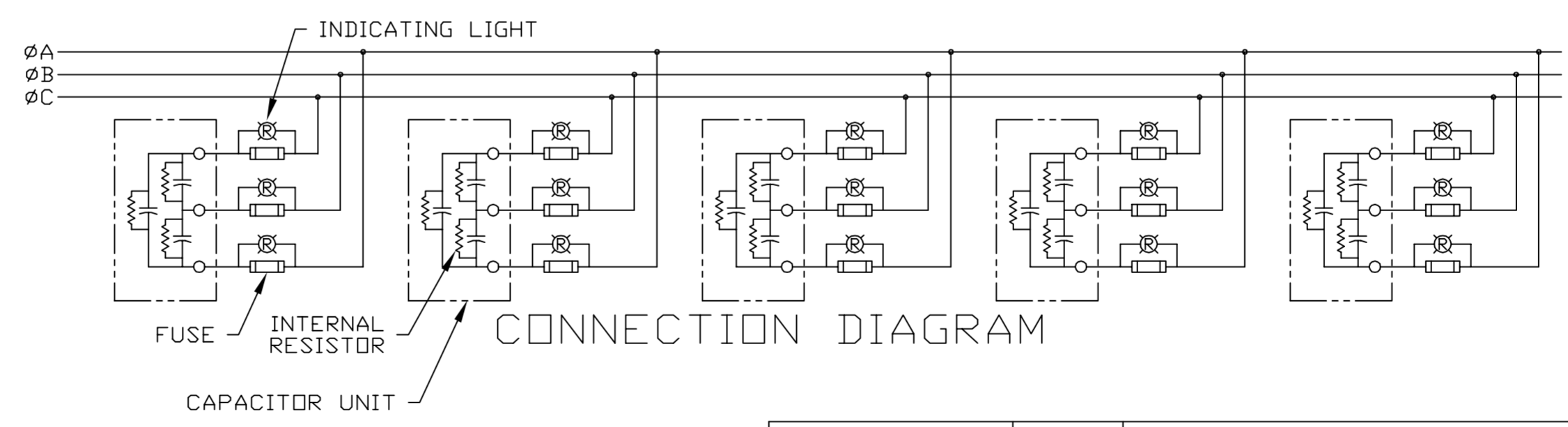

CAT 65L943TE2 SERNO
 KVAR 500 60Hz 3ph
 VOLT 480 DIAG 186C3233HB
 CONN DELTA
 Read instructions: GEH-2728

SIGNATURES		DATE
DRAWN E.McGINN		10/1/92
CHECKED		
ENGR		
ISSUED		9/30/93
CAD SYS. NO.		
AUTOCAD		

INDUSTRIAL SYSTEMS
 FORT EDWARD, N.Y., U.S.A.

OUTLINE
 65L943TE2

FIRST MADE FOR:

SIZE	FSCM NO.	DWG NO.	REV
C		65L943TE2	1
SCALE	SHEET 1		CONT ON SHT -

413
DISTR TO