

8.4 kV MCOV

SIZE A	DWG NO 911XPE010AS	SHT 1	REV
REV	DESCRIPTION	DATE	APPROVED

LINE TERMINAL DETAIL

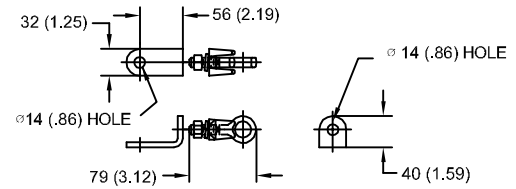

HDG TERMINAL BRACKET
 ONE HDG TERMINAL
 SUITABLE FOR CU OR AL CONDUCTOR SIZE
 φ 7 (.25) - φ 21 (.81) DIA
 25 - 240 sq mm
 AWG#4 - 500 MCM

GROUND TERMINAL DETAIL

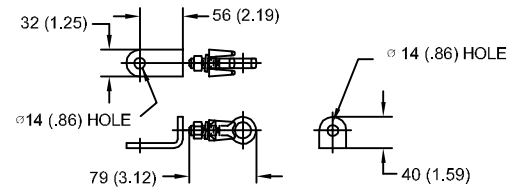

HDG TERMINAL BRACKET
 ONE HDG TERMINAL
 SUITABLE FOR CU OR AL CONDUCTOR SIZE
 φ 7 (.25) - φ 21 (.81) DIA
 25 - 240 sq mm
 AWG#4 - 500 MCM

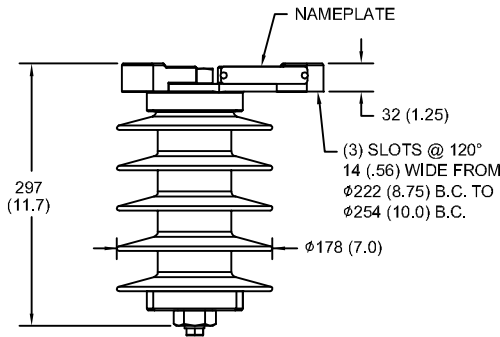

CHARACTERISTICS

RATED VOLTAGE	10 kVrms
MCOV	8.4 kVrms
MASS	6.8 kg (15.0 lb)
COG ABOVE BASE	150 (5.9)
CREEPAGE DISTANCE	765 (30.1)
STRIKE DISTANCE	221 (8.7)
LIGHTNING IMP W/S	127 kVpk
SWITCHING IMP WET W/S	106 kVpk
POWER FREQ WET W/S	63 kVrms
TOV 1s NO PRIOR DUTY	11.9 kVrms
TOV 10s NO PRIOR DUTY	11.4 kVrms
TOV 1s W/PRIOR DUTY	11.6 kVrms
TOV 10s W/PRIOR DUTY	11.1 kVrms

CANTILEVER FORCE

MAXIMUM CONTINUOUS	2974 N (669 lbs)
ULTIMATE (max pk)	5947 N (1337 lbs)

RECOMMENDED CLEARANCE (CENTER - CENTER)

PHASE TO GROUND	114 (4.5)
PHASE TO PHASE	229 (9.0)

- NOTES:
 1. DIMENSIONS IN millimeters(inches) SUBJECT TO ±3% TOLERANCE
 2. CLEARANCE AND INSULATION W/S VOLTAGE APPLY AT SEA LEVEL
 3. ARRESTER SUITABLE FOR OPERATION AT ALTITUDES UP TO 1800 m (6000 ft)
 4. PACKAGED IN A CORRUGATED BOX.

.5μSEC 10kA IR kV	SWITCHING SURGE IR kV		MAXIMUM 8/20 DISCHARGE VOLTAGE - kV AT					
	500 A	1 KA	1.5 kA	3.0 kA	5 kA	10 kA	20 kA	40 kA
29.4	19.8	20.6	21.1	22.2	23.3	25.0	27.0	30.8



GE ENERGY
 FORT EDWARD, N.Y., U.S.A.

SIZE
A

ANSI
 STATION CLASS

ARRESTER
9L11XPE010AS

DRAWN JBC DATE 5/03/2011

ISSUED DATE 5/03/2011

SCALE

SHEET 1 CONT ON -

DISTR. TO