



TECHNICAL DATA SHEET

Description	Date	Prepared by
Rev. A Issued for proposal.	14.03.2017	A. Roosipuu
Rev. B -	-	-
Rev. C -	-	-

GENERAL DATA

P1010 Document number	TRTDS0000898-01
P1020 Item code	39332
P1030 Project	XKIB-IEC 10/400/7-50
P1032 Grid Solutions Oy (Ltd.) item code	JC301116-00
P1040 Application	Three phase Blocking reactor
P1050 Inductor type	Vacuum impregnated (VI) dry type steel core inductor
P1060 Cooling method	AN
P1070 Installation altitude	< 1000 m above sea-level
P1080 Standards	IEC 60076-6

ELECTRICAL DATA

P2010 Nominal inductance [-3 % ... +3 % at 50 Hz]	3,833 mH
P2020 Nominal frequency	50 Hz
P2040 Nominal operating voltage [Vrms]	400 V
P2050 Nominal current [rms]	16,8 A
P2061 Fundamental current (50Hz)	15,8 A
P2071 Total losses	382 W

ADDITIONAL TECHNICAL DATA

P3010 Min. Cooling Air Flow Speed	Natural convection
P3020 Max ambient temperature	40,0 °C
P3030 Installation environment	Indoor
P3040 Storage temperature	-30 °C ... + 70 °C
P3050 Transportation temperature	-30 °C ... + 70 °C
P3060 Humidity, non condensing	Max 95 %
P3070 Protection class	IP 00
P3080 Pollution degree IEC 60664-1	2
P3100 Thermal class of insulation material	F
P3110 Total weight	13 kg
P3120 Impregnation method	Vacuum
P3130 Duty class	Continuous

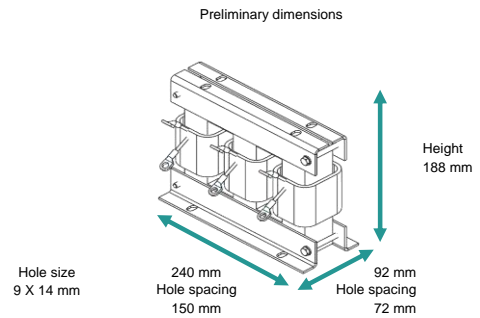

TESTS

P4010 Routine tests	
P4020 Visual inspection	For all units
P4030 Insulation voltage test winding to winding 50Hz/1s	4 kV
P4040 Insulation voltage test winding to core 50Hz/1s	4 kV
P4060 Inductance test	Ln (-3 % ... +3 %) For all units

DOCUMENTATION

P5010 Drawing document number	TRDOC0189704-01
-------------------------------	-----------------

NOTES

P9010 Manufacturing location	Made in EU
------------------------------	------------